



REINFORCED VAPOR PROTECTION



ARCHITECTURE · ENGINEERING SPECIFICATION GUIDE

REINFORCED VAPOR RETARDER SYSTEM

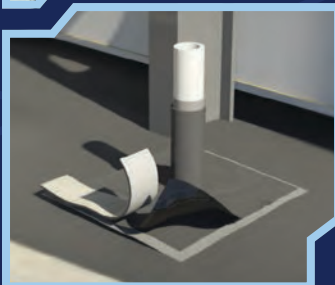

UNDER SLAB

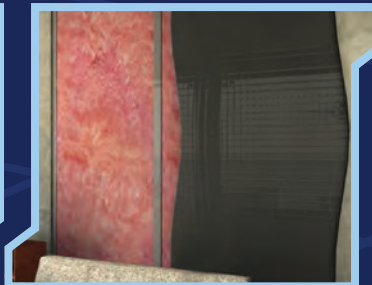

WALL



ROOF DECK



CRAWL SPACE

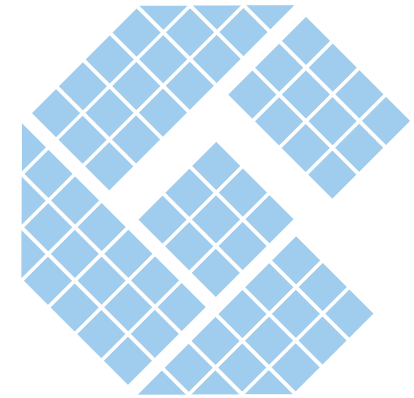

GRIFFOLYN® REINFORCED VAPOR RETARDER SYSTEMS

ABOUT REEF INDUSTRIES, INC.

Founded as the original division of Reef Industries in 1957, Griffolyn® introduced a newly patented process to manufacture internally reinforced film laminates. The result was high strength, lightweight and ruggedly durable materials that offered easy-to-use and cost-effective solutions to vapor control problems.

The heavier and more tedious to install materials then in use, were rapidly replaced as Griffolyn® systems became recognized as the state of the art technology.

Over the years, new technologies and innovations spawned a variety of new manufacturing techniques and product lines.

The increasing scope and range of production capability encompassed additional product offerings and in 1976, the corporate identity of Reef Industries, Inc. was adopted.

Reef Industries is headquartered in Houston, Texas and operates six product divisions including Griffolyn®. A state-of-the-art manufacturing facility and a fabrication plant support a worldwide sales network.

Technical support and research groups, staffed by knowledgeable engineers and chemists, work closely with the most experienced sales department in the industry. This team is uniquely qualified to provide extensive support services to Griffolyn® specifiers and customers.

CONTENT

| | |
|---|---------|
| CONSIDERATIONS FOR DESIGNERS AND SPECIFIERS | 4 - 5 |
| UNDER SLAB APPLICATIONS | 6 - 7 |
| WALL APPLICATIONS | 8 - 9 |
| ROOF APPLICATIONS | 10 - 11 |
| CRAWL SPACE APPLICATIONS | 12 - 13 |
| APPLICATION SELECTOR GUIDE | 14 - 15 |
| PHYSICAL PROPERTIES & TYPICAL VALUES | 16 - 19 |

*Proven performance
for over 55 years*

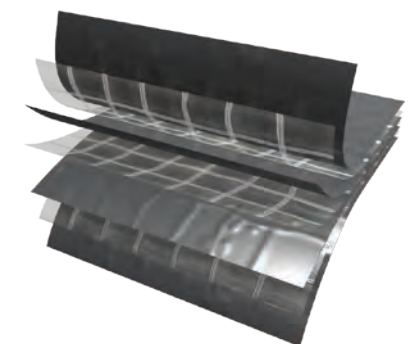

2

3



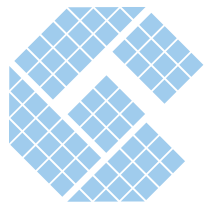

CONTINUING EDUCATION

Reef Industries now sponsors a continuing education course to help you earn 1.00 AIS/CES credit toward completion of your 18 required learning unit hours. **Vapor Control: Considerations for Designers and Specifiers** can be found on the McGraw Hill Construction Continuing Education Center website.

The course covers moisture basics and provides in-depth information about the environmental benefits, applications and selection criteria for vapor retarder systems, as well as standard code requirements.



For more info scan the QR Code.



| | |
|---|-------------------|
| CONSIDERATIONS FOR DESIGNERS AND SPECIFIERS | 4 - 5 |
| UNDER SLAB APPLICATIONS | 6 - 7 |
| WALL APPLICATIONS | 8 - 9 |
| ROOF APPLICATIONS | 10 - 11 |
| CRAWL SPACE APPLICATIONS | 12 - 13 |
| APPLICATION SELECTOR GUIDE | 14 - 15 |
| PHYSICAL PROPERTIES & TYPICAL VALUES | 16 - 17 - 18 - 19 |

CONSIDERATIONS FOR DESIGNERS AND SPECIFIERS

Moisture Problems in Buildings

Each year, countless building owners suffer problems associated with material and system failures due to moisture. Anyone who has faced a shutdown or limited use of their facility due to a wall system, roof assembly or flooring failure can attest to the cost and inconveniences involved.

There is much to motivate design professionals to utilize every available means to avoid and minimize the potential for these problems:

- Inconvenience to the owner/client
- Monetary loss from disrupted operations
- Bad publicity
- Potential impact on "Errors and Omissions" insurance premiums
- Adverse effects on indoor air quality
- Design liability exposure and litigation
- High repair costs

Water Vapor Migration

One of the primary functions of the building thermal envelope is to maintain desirable temperature and humidity for occupant comfort. Within the range of temperatures encountered in buildings, water may exist as a vapor, liquid or solid. Moisture-related problems in buildings may arise from:

1. The presence of too much moisture
2. Changes in moisture content
3. Effects of a change of state, such as freezing within wall cavities
4. Deterioration of materials due to corrosion of metals, or rotting of wood framing

In the design, specification and construction of the building envelope, the behavior of moisture must be considered, particularly the occurrence of condensation. Problems may arise when moisture comes into contact with a cold surface such as a window, or within outdoor walls or roof-ceiling assemblies. Condensation within walls that enclose air conditioned spaces must be considered in warm humid climates.

Moisture moves in air due to differences in vapor pressure, but also with movement of the air itself. The causes of air motion through construction assemblies must be considered, especially infiltration and exfiltration at windows, doors and other penetrations of the building envelope.

Vapor Retarders and Air Barriers

Most building materials are permeable to moisture. Porous materials that become saturated with moisture lose their insulating ability and may not regain it when dry. Walls are particularly susceptible, and moisture migration should be prevented or minimized by use of low permeance membranes, called vapor retarders (formerly referred to as vapor barriers).

A vapor retarder is a material that has a flow rating of one perm or less (1 perm = 1 grain/hr·ft²·in Hg). Permeability of one perm is often still too high for a vapor retarder to be effective in most building applications. A lower permeability rating is generally required. As a general rule, vapor retarders should be installed as close as possible to the side of the assembly through which moisture enters. Air barriers are designed to stop the movement of air, which can cause not only convective heat flow, but movement of large volumes of moisture along with the air.

Permeability, Strength, Durability, Fire Retardancy

Low permeability, high strength, and durability are the primary selection and specification criteria. Additionally, building code provisions may sometimes require use of materials which are fire retardant. Vapor retarders should be selected according to their intended performance, as determined by recognized, industry standard test methods.

The investment made in selecting and specifying an effective vapor retarder system during the design and construction process are only pennies per square foot. The cost of corrective measures required by improperly installing a vapor retarder, installing the wrong vapor retarder, or not installing one at all, has proven to be many dollars per square foot.

NOTES TO SPECIFIER: Careful placement and sealing of vapor retarder materials is essential to ensure effective moisture vapor control. Perforation of the membrane for any reason will limit its effectiveness and can be responsible for failure at the time of installation. The use and placement of vapor retarders should be determined by a qualified design professional familiar with their use, and with local climatic conditions. In no case should two non-permeable materials be used in the same assembly since moisture could be trapped between them, resulting in extensive damage. By design, Griffolyn® Vapor Retarders are not "breathable" (vapor permeable) and are not appropriate for use where breathable materials are required.

Sources of Vapor Retarder Problems

By understanding some of the pitfalls surrounding the effective installation of vapor retarders, specifiers can head off potential problems and failures. Contractors must install vapor retarder systems correctly by following the project specifications and the manufacturer's installation recommendations. Some of the most common problems of vapor retarder systems include:

- Placing concrete on a vapor retarder rather than an absorptive base such as sand or gravel increases the water "bleeding" period. Concrete finishers sometimes poke holes in the vapor retarder to allow water to disperse so they can start work sooner.
- Workers often puncture the vapor retarder with stakes while placing edge forms and reinforcing bar supports.
- Vehicular traffic before and during concrete placement can rip thin, non-reinforced plastic sheets or cause underlying sharp aggregate to make thousands of tiny perforations in the vapor retarder material.
- Unsealed openings may occur along lapped edges of the vapor retarder, at intentional penetrations for pipes, conduits, outlet boxes and at the floor-wall intersection. The vapor retarder should be pulled up and sealed to the footing or foundation wall.



CONSIDERATIONS FOR DESIGNERS AND SPECIFIERS 4 - 5
 UNDER SLAB APPLICATIONS 6 - 7
 WALL APPLICATIONS 8 - 9
 ROOF APPLICATIONS 10 - 11
 CRAWL SPACE APPLICATIONS 12 - 13
 APPLICATION SELECTOR GUIDE 14 - 15
 PHYSICAL PROPERTIES & TYPICAL VALUES 16 - 17 - 18 - 19



UNDER SLAB APPLICATIONS

Natural soil capillarity can allow large volumes of moisture to contact the underside of a slab. Properly formed capillary breaks within the soil foundation system, combined with a high performance vapor retarder, are the first lines of defense. Without an under slab vapor retarder, moisture can be forced upwards under pressure into habitable space. Mineral salts from the ground and from the concrete itself can be transported through the slab to the underside of the flooring system causing visible efflorescence and staining.

Some of the problems commonly associated with moisture migration through the slab include:

- 💧 Deterioration of flooring adhesive
- 💧 Color changes
- 💧 Peaking, curling, or warping of flooring
- 💧 Bumps, ridges or bubbles under flooring
- 💧 Mold, mildew and bacteria growth
- 💧 Efflorescence (build-up of mineral salts)

The majority of flooring failures result directly from a high emission of moisture from the concrete slab. It is said that moisture is the largest single problem in the flooring and coated surfaces industries today.

Many of the vapor retarders installed under building slabs do not perform adequately due to improper placement or puncturing. Ineffective vapor retarders will not reduce permeability enough to control even the small amount of moisture it takes to interfere with the bond integrity of modern flooring systems.

The need for an under slab vapor retarder in high humidity areas with high water tables is well understood. However buildings in arid climates also need vapor retarders. Air conditioning the interior of the structure creates a significant difference in vapor pressure which can cause moisture to be drawn out of the ground (an area of relatively high vapor pressure) through the slab and into the space above (an area of low vapor pressure). Landscape irrigation systems, planters, broken plumbing pipes and other water sources can lead to moisture problems, even in arid regions.

All major flooring manufacturers have specifications requiring moisture tests before installation of their flooring materials. Even if new concrete is allowed to dry to the point where flooring can safely be installed, the absence or improper installation of a vapor retarder can lead to expensive failures later. Research into moisture-related flooring failures has shown a high correlation between the severity of the failure and the absence of a vapor retarder.

Buildings without a vapor retarder will not necessarily have moisture problems. However, buildings with vapor emission problems are usually found to have inadequate vapor retarders.

ASTM Standards

There are two ASTM standards for vapor retarders under concrete slabs, ASTM E-1745-09 "Standard Specifications for Water Vapor Retarders Used in Contact with Soil or Granular Fill Under Concrete Slabs". ASTM E-1745-09 list three classifications which may be used to specify vapor retarders.

The second standard is ASTM E-1643-10 "Practice for Selection, Design, Installation and Inspection of Water Vapor Retarders Used in Contact with Earth or Granular Fill Under Concrete Slabs".



- 

Griffolyn® Type-65
Reinforced high density 3 ply. General purpose that meets the strength and permeance requirements of most applications.
- 

Griffolyn® Type-65 Geotextile
Combines Griffolyn® reinforced high density polyethylene with a non-woven geotextile for an under slab vapor retarder with superior puncture resistance.
- 

Griffolyn® Type-85
Reinforced high density 5 ply. Offers greater strength and lower permeance for a higher level of integrity in roofing and under slab applications.
- 

Griffolyn® Type-105
Reinforced high density 7 ply. Extra strength and extra low permeance needed to meet additional requirements of wood flooring, special coatings and special flooring systems.
- 

Griffolyn® VAPORGUARD®
3 ply. Combines HDPE/LLDPE and aluminum to provide an extremely low permeance for special applications such as radon protection, cold storage, museums and computer rooms.
- 

Griffolyn® 10 Mil Green
Co-extruded polyolefin membrane with superior puncture resistance, impact and tensile strength.
- 

Griffolyn® 15 Mil Green
Co-extruded polyolefin membrane with superior puncture resistance, impact and tensile strength.

SYSTEM COMPONENTS



Fab Tape™
Double-Sided Asphaltic Mastic. Creates a durable field seam between multiple vapor retarder sections.



Griffolyn® Ultra VR Tape
White, rubber based adhesive tape with a polyethylene film.



Pipe Boot
Form fitted boots to seal penetrations and pipes.

💧 Avoid Flooring Failures

The majority of flooring failures result directly from a high emission of moisture from the concrete slab. Slab moisture is the largest single problem in the flooring and coated surface industries today. The low permeance and high strength of Griffolyn® under slab vapor retarders effectively control under slab moisture infiltration, preventing expensive flooring failures.

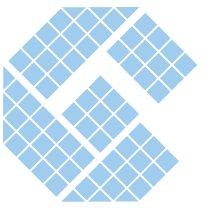

WALL APPLICATIONS

Properly protecting the building envelope from mold and degradation caused by moisture infiltration usually requires the use of a vapor retarder in wall assemblies. This is especially true in regions where there is a substantial difference between inside and outside moisture levels, which can create a large vapor pressure differential.

Moisture is introduced into walls through both air leaks (convection) and vapor diffusion. Of these two methods, air leaks present a greater potential for causing moisture damage. It is estimated that air leakage through a hole of less than one square inch can allow passage of up to nearly eight gallons of water into the building envelope over the course of a single heating season. A high quality vapor retarder might be able to eliminate condensation caused by diffusion, but even an excellent vapor retarder is of little use if it can be bypassed by convective currents.

Griffolyn® vapor retarders effectively control air leaks and vapor diffusion to reduce the amount of moisture infiltration into the building.

The effectiveness of the vapor retarder will be greatly affected by the number of penetrations through the material made during installation. All penetrations should be sealed with a Pipe Boot, Fab Tape™, Griffolyn® Sealant Tape and Griffolyn® FR Tape before finishing the wall.

The location of a Griffolyn® vapor retarder in the structure depends upon whether the building is to be located in a predominantly heating climate or cooling climate. The concept is to keep the vapor retarder on the warm side of the dew point to prevent condensation on cold surfaces inside the wall. The same consideration applies when placing vapor retarders in roof deck assemblies. For design standards and more information, consult the ASHRAE "Handbook of Fundamentals" published by The American Society of Heating, Refrigeration and Air Conditioning Engineers.

Griffolyn® Vapor Retarder Materials

The main components of the Griffolyn® system are several grades of high performance polyethylene vapor retarder material made of HDPE (high density polyethylene), LDPE (low density polyethylene), or LLDPE (linear low density polyethylene). They are reinforced with a heavy-duty polyester cord grid for high strength and durability.

Vapor retarders can be manufactured in sizes to meet project requirements up to 100' x 100' (30m x 30m), greatly reducing the number of in-field seams and the potential for failure.

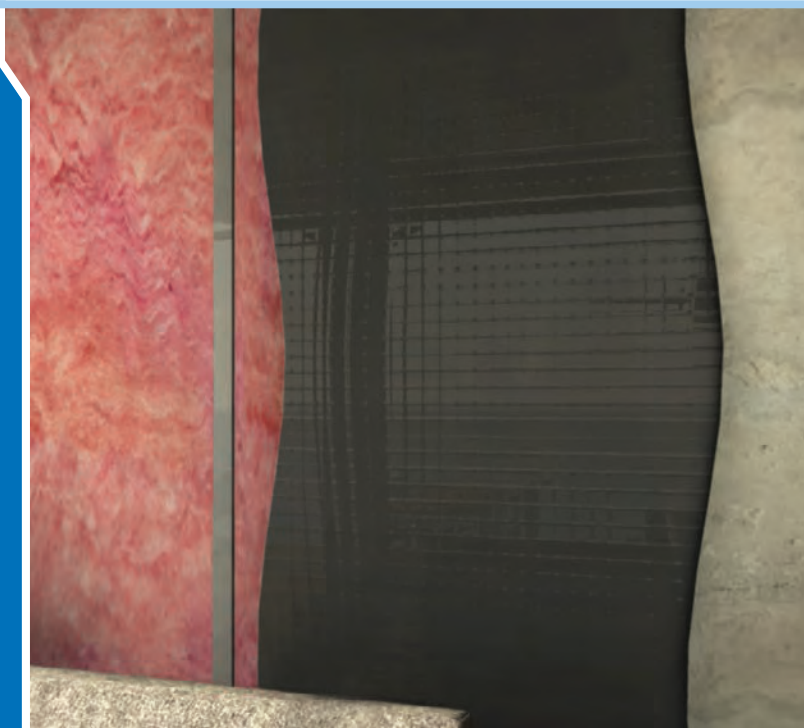

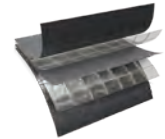

- 

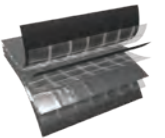
Griffolyn® Type-65
Reinforced high density 3 ply. General purpose that meets the strength and permeance requirements of most applications.
- 

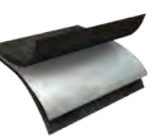
Griffolyn® Type-85
Reinforced high density 5 ply. Offers greater strength and lower permeance for a higher level of integrity in roofing and under slab applications.
- 

Griffolyn® Type-105
Reinforced high density 7 ply. Extra strength and extra low permeance needed to meet additional requirements of wood flooring, special coatings and special flooring systems.
- 

Griffolyn® VAPORGUARD®
3 ply. Combines HDPE/LLDPE and aluminum to provide an extremely low permeance for special applications such as radon protection, cold storage, museums and computer rooms.
- 

Griffolyn® Type-55 FR
Reinforced fire retardant 3 ply. General purpose vapor retarder for use in walls, ceilings and roof assemblies.
- 

Griffolyn® TX-1200 FR
Reinforced fire retardant 3 ply. Offer greater strength and lower permeance. Qualifies as Class A building product for a higher level of integrity in walls, ceilings and roof assemblies.
- 

Griffolyn® Type-90 FR
Reinforced fire retardant 5 ply. Delivers extra strength and extra low permeance for applications with extreme temperature variations.

Control Moisture Infiltration

Moisture Infiltration in wall cavities can result in mold and decay problems. Damaging moisture is introduced into wall cavities through air leaks and vapor diffusion. Griffolyn® vapor retarders effectively control moisture infiltration into the building envelope.

SYSTEM COMPONENTS



Fab Tape™
Double-Sided Asphaltic Mastic. Creates a durable field seam between multiple vapor retarder sections.

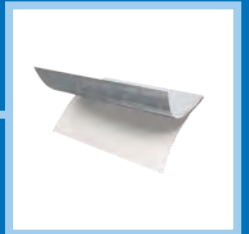

Griffolyn® Sealant Tape
Pressure Sensitive adhesive backed polyethylene tape.



Griffolyn® FR Tape
White, fire retardant pressure sensitive tape.



Pipe Boot
Form fitted boots to seal penetrations and pipes.

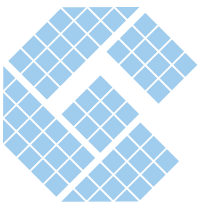

ROOF APPLICATIONS

Some buildings generate large amounts of moisture as a result of activities or processes they contain. Examples include natatoriums, manufacturing facilities, certain industrial processes and food plants.

As a result of condensation which can occur within the roof assembly, these buildings may experience problems with saturated insulation, structural corrosion, staining, mildew growth, and other moisture-related problems.

An effective vapor retarder system located on the warm side of the dew point can stop water vapor from reaching a temperature or location where it can cause loss of insulation performance or serious damage. For many years the National Roofing Contractors Association (NRCA) has maintained that vapor retarders should be considered for use in low-slope membrane roof assemblies where:

💧 *The outside average January temperature is below 40 degrees F (4°C) and the expected interior winter humidity is 45% or greater.*

ASHRAE has also developed design criteria for low sloped roofs. Consult their "Handbook of Fundamentals" for methodology on use of vapor retarders. NRCA recommends that when ASHRAE guidelines are followed, the vapor retarder:

- 💧 Permeability rating should approach 0 perm
- 💧 Should be completely sealed at side and end laps
- 💧 Should be sealed and flashed at all roof perimeters and penetrations
- 💧 Should envelope the vertical edges of insulation boards
- 💧 Must be able to resist damage from hot asphalt or specified adhesives
- 💧 Should be chemically compatible with conventional roofing materials
- 💧 May need to have good adhesion and shear properties

Roof Vapor Retarders

Made from durable and strong, internally reinforced polyethylene laminates, the Griffolyn® System withstands extreme temperatures and is highly resistant to punctures and tears. Griffolyn® Vapor Retarders are available in stock sizes, which are available for immediate shipment. This product can also be manufactured in sizes to meet project requirements up to 100' x 100' (30m x 30m), greatly reducing in-field seams and the potential for failure.

If building codes require a fire retardant vapor retarder, Reef Industries provides a line of fire retardant vapor retarder materials that pass NFPA 701 Large Scale "Standards Methods of Fire Tests for Flame-Retardant Textiles and Films." They have a Class 1 / Class A Flame Spread Rating per UBC-42 and ASTM E-84.

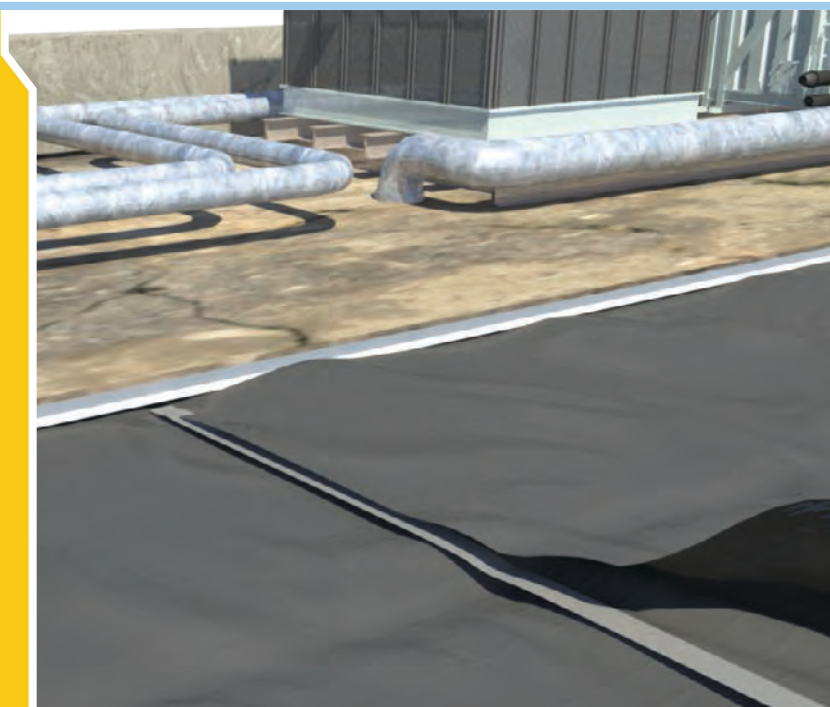

- 

Griffolyn® Type-65
Reinforced high density 3 ply. General purpose that meets the strength and permeance requirements of most applications.
- 

Griffolyn® Type-85
Reinforced high density 5 ply. Offers greater strength and lower permeance for a higher level of integrity in roofing and under slab applications.
- 

Griffolyn® Type-105
Reinforced high density 7 ply. Extra strength and extra low permeance needed to meet additional requirements of wood flooring, special coatings and special flooring systems.
- 

Griffolyn® VAPORGUARD®
3 ply. Combines HDPE/LLDPE and aluminum to provide an extremely low permeance for special applications such as radon protection, cold storage, museums and computer rooms.
- 

Griffolyn® Type-55 FR
Reinforced fire retardant 3 ply. General purpose vapor retarder for use in walls, ceilings and roof assemblies.
- 

Griffolyn® TX-1200 FR
Reinforced fire retardant 3 ply. Offer greater strength and lower permeance. Qualifies as Class 1 building product for a higher level of integrity in walls, ceilings and roof assemblies.
- 

Griffolyn® Type-90 FR
Reinforced fire retardant 5 ply. Delivers extra strength and extra low permeance for applications with extreme temperature variations.

💧 Stop Water Vapor

Moisture in the roof assembly can cause structural corrosion, staining, mold and mildew growth and saturated insulation.

A Griffolyn® vapor retarder system can stop water vapor from causing loss of insulation performance, structural damage and other moisture-related problems.

SYSTEM COMPONENTS



Fab Tape™

Double-Sided Asphaltic Mastic. Creates a durable field seam between multiple vapor retarder sections.

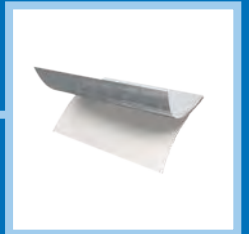

Griffolyn® Sealant Tape

Pressure Sensitive adhesive backed polyethylene tape.



Griffolyn® FR Tape

White, fire retardant pressure sensitive tape.



Pipe Boot

Form fitted boots to seal penetrations and pipes.

CONSIDERATIONS FOR DESIGNERS AND SPECIFIERS 4 - 5
 UNDER SLAB APPLICATIONS 6 - 7
 WALL APPLICATIONS 8 - 9
 ROOF APPLICATIONS 10 - 11
 CRAWL SPACE APPLICATIONS 12 - 13
 APPLICATION SELECTOR GUIDE 14 - 15
 PHYSICAL PROPERTIES & TYPICAL VALUES 16 - 17 - 18 - 19

CRAWL SPACE APPLICATIONS

Ventilated dirt crawl spaces provide a source of moisture that can lead to mold, mildew, fungus and even structural decay. A crawl space can foster environments that lead to severe health issues, environmental moisture problems and increased energy consumption. Therefore, a crawl space needs to be sealed with a vapor retarder to help maintain humidity levels for occupant comfort, reduce heating and cooling costs and minimize other moisture related problems.

The Griffolyn® crawl space vapor retarder system is made up of several grades of high performance polyethylene material. Griffolyn® crawl space vapor retarders are available in white polyethylene allowing greater illumination for a cleaner, more attractive crawl space. This product can be manufactured in sizes to meet specific project requirements to greatly reduce the number of in-field seams and the costs associated with the time and labor required to cut the product to size in the field.

Antimicrobial additives in Griffolyn® Plastic Products

Reef Industries introduces the use of antimicrobial films and reinforced laminates that prevent the growth of harmful bacteria, fungi, mold and algae. The antimicrobial additive inhibits and/or kills bacteria, fungi, and mildew where the prevention of microbial growth is critical.

1. Healthcare Facilities
2. Food Processing Plants
3. Research Centers
4. Commercial & Residential Crawl Space

Griffolyn®'s antimicrobial materials provide unique performance characteristics:

- Non-migratory
- Wash resistant
- Non-toxic and environmentally safe
- Durable and tear resistant
- Very stable in a wide range of environments across a broad temperature range

Radon Control

Radon Gas is a naturally occurring by-product from the decay of uranium in the soil. It can enter buildings through cracks in foundation walls and floor slabs. High levels of radon in buildings have been linked to increased risk of lung cancer. The use of vapor retarders can effectively reduce the amount of radon entering a building when used as part of a complete radon control system.

Crawl Space Moisture

One of the leading sources of health related problems and moisture related damage to a home is caused by ventilated dirt crawl spaces.

Ventilated dirt crawl spaces provide a source of moisture that can lead to mold, mildew, fungus and even structural wood damage. It has been shown that unvented and conditioned crawl spaces with an effective crawl space membrane provide better moisture control than vented crawl spaces.

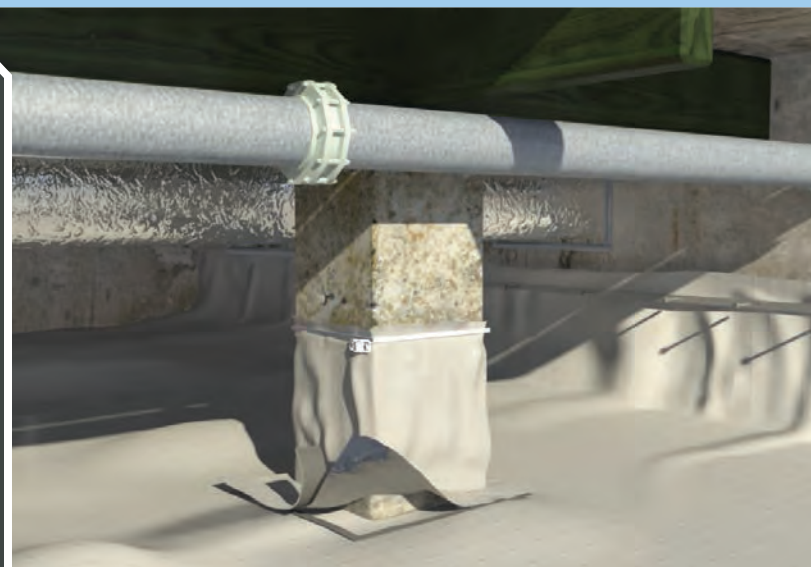

- Griffolyn® 20 Mil Reinforced**
Reinforced 3 ply. Laminate combining two white films with a high strength cord grid.
- Griffolyn® Type-90**
Reinforced 5 ply. Delivers extra strength for applications requiring additional strength and puncture resistance.
- Griffolyn® TX-1600 or TX-1600 Antimicrobial**
Reinforced 3 ply. Combines 2 layers of U.V. stabilized coextruded polyethylene and a high strength cord grid.
- Griffolyn® TX-1200**
Reinforced 3 ply laminate. Provides high strength and durability in a lightweight material.
- Griffolyn® Type-90 FR**
Reinforced fire retardant 5 ply. Delivers extra strength and extra low permeance for application with extreme temperature variation.

Indoor Air Quality

An important issue receiving a lot of attention lately is the subject of so-called "sick building syndrome," it can have many causes including dangerous molds, bacteria, mildew, gasses given off by building materials, and inadequate ventilation. Indoor air quality (IAQ) problems don't just make a building "sick"; they also carry with them a high degree of human health risk.

There is growing evidence that many of these problems are made worse, if not caused by, unwanted moisture in buildings. Much of this moisture enters through exterior walls and floor slabs. Mold, mildew, and other organisms feed on organic materials in the building. They often flourish in wall cavities and in the dark, moist environment under flooring materials and carpeting.

SYSTEM COMPONENTS



Fab Tape™

Double-Sided Asphaltic Mastic. Creates a durable field seam between multiple vapor retarder sections.

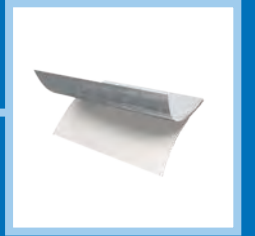

Griffolyn® Sealant Tape

Pressure Sensitive adhesive backed polyethylene tape.



Griffolyn® FR Tape

White, fire retardant pressure sensitive tape.



Griffolyn® Ultra VR Tape

White, rubber based adhesive tape with a polyethylene film.



Pipe Boot

Form fitted boots to seal penetrations and pipes.

CONSIDERATIONS FOR DESIGNERS AND SPECIFIERS 4 - 5
 UNDER SLAB APPLICATIONS 6 - 7
 WALL APPLICATIONS 8 - 9
 ROOF APPLICATIONS 10 - 11
 CRAWL SPACE APPLICATIONS 12 - 13
 APPLICATION SELECTOR GUIDE 14 - 15
 PHYSICAL PROPERTIES & TYPICAL VALUES 16 - 17 - 18 - 19



APPLICATION SELECTOR GUIDE

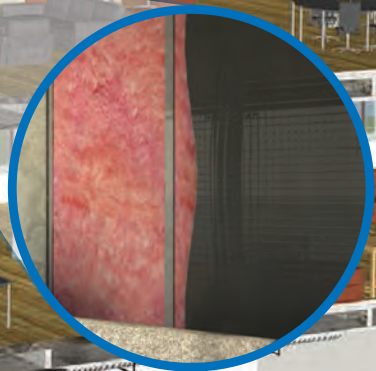
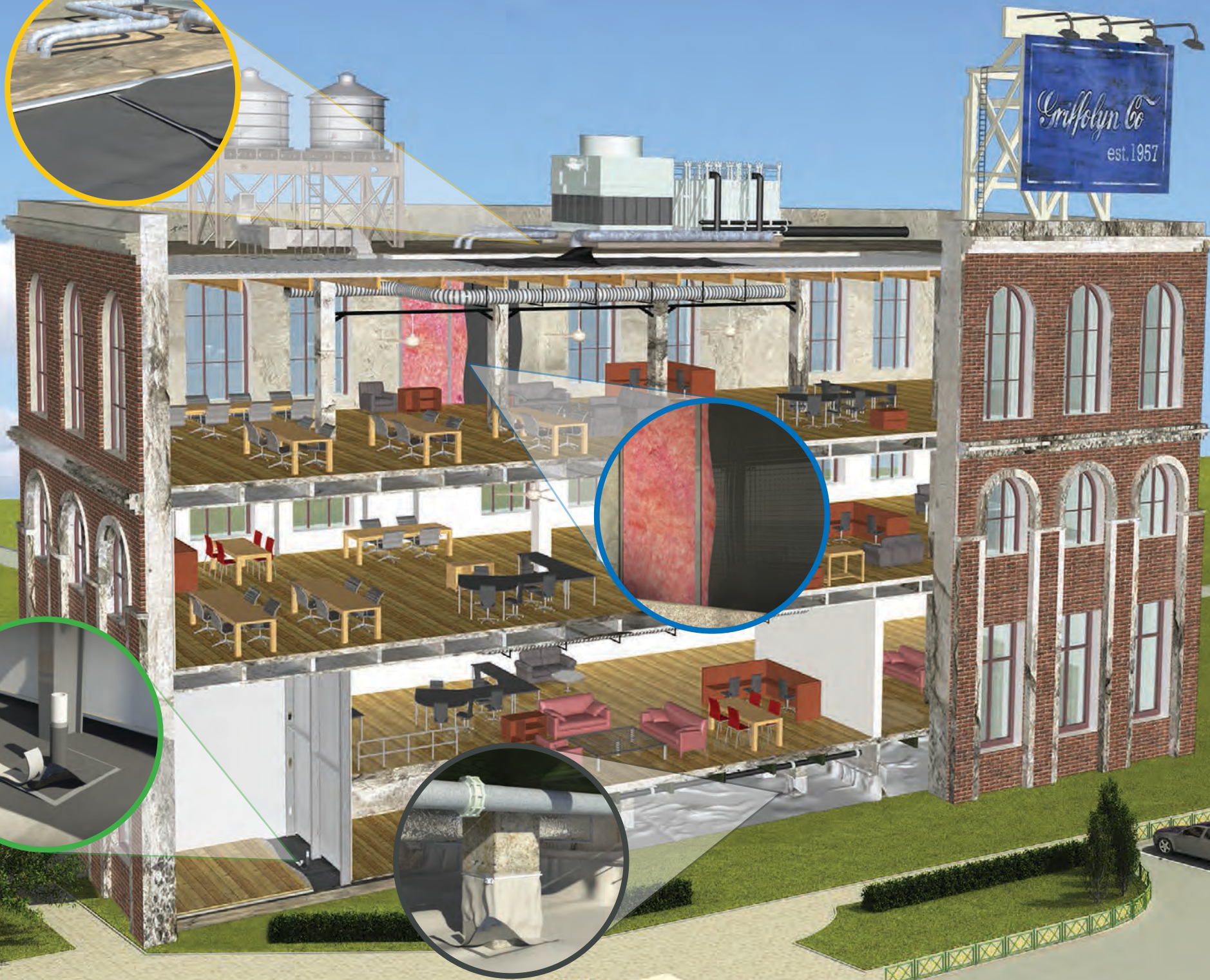
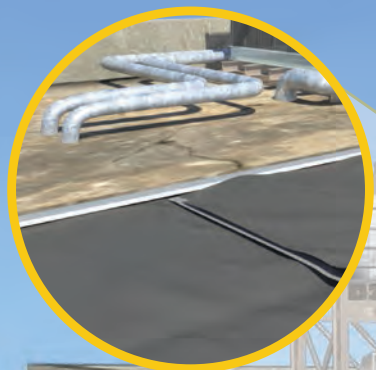

ROOF APPLICATIONS

- 07 22 00 Roof and Deck Insulation
- 07 40 00 Roof Panels
- 07 50 00 Membrane Roofing
- 07 61 00 Sheet Metal Roofing
- 09 50 00 Ceilings

WALL APPLICATIONS

- 07 42 00 Wall Panels
- 07 46 00 Siding
- 09 20 00 Plaster & Gypsum Board

UNDER SLAB APPLICATIONS

- 09 62 00 Specialty Flooring
- 09 64 00 Wood Flooring
- 09 65 00 Resilient Flooring
- 09 66 00 Static Control Flooring
- 09 67 00 Fluid Applied Flooring
- 09 68 00 Carpeting

CRAWL SPACE APPLICATIONS

- 07 11 19 Crawl Space Sheet Damp Proofing



PHYSICAL PROPERTIES & TYPICAL VALUES

UNDER SLAB APPLICATIONS

ASTM D-3776 / Weight

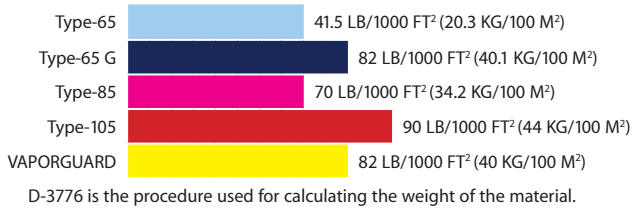

ASTM D-2582 / Puncture Propagation Tear

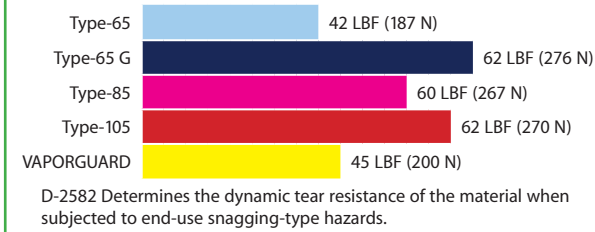

ASTM E-96 / Permeance (PERM)

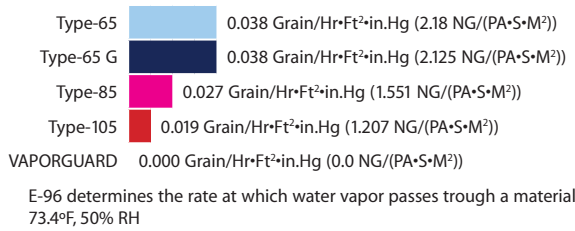

ASTM D-1709 / Puncture Resistance

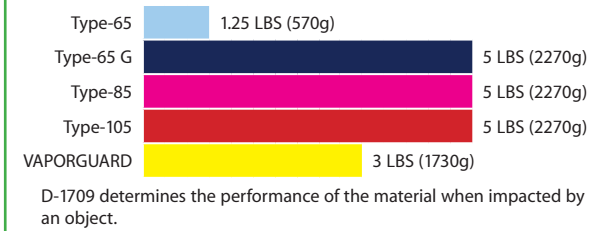

ASTM D-882 / 3" Tensile Strength

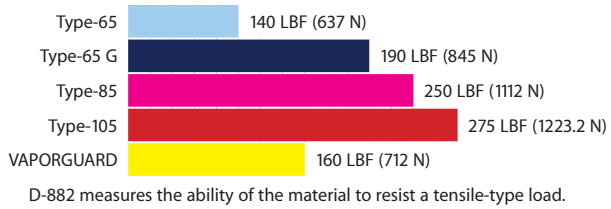

ASTM D-4833 / Puncture Strength

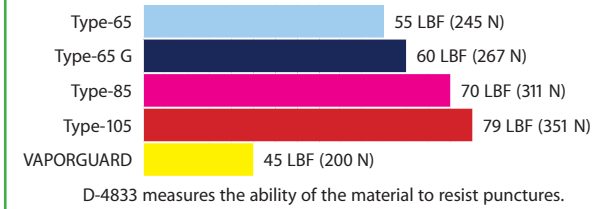

Standard Specification for Water Vapor Retarders Used in Contact with Soil or Granular Fill Under Concrete Slabs. ASTM E-1745-09

Permeance ASTM E-96 (B) (ASTM E-154 Section 7)

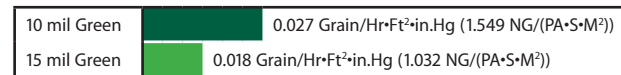

Tensile Strength ASTM D-882 (ASTM E-154 Section 9)

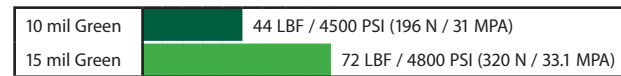

Puncture Resistance ASTM D-1709 Method B



WALL AND ROOF APPLICATIONS

ASTM D-3776 / Weight

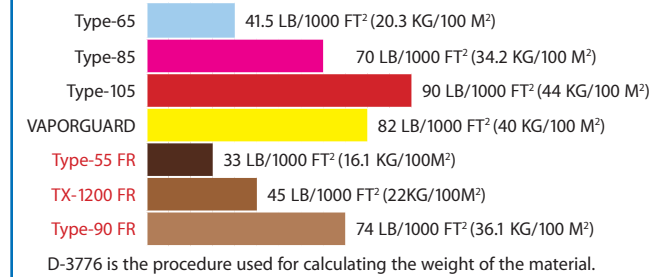

ASTM D-2582 / Puncture Propagation Tear

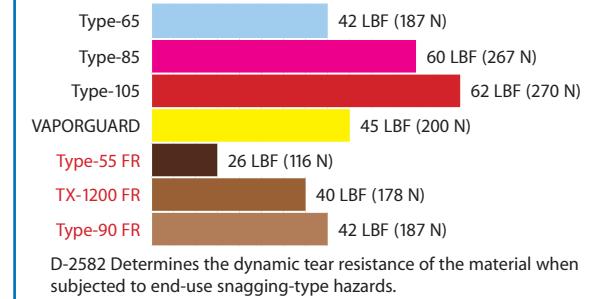

ASTM E-96 / Permeance (PERM)

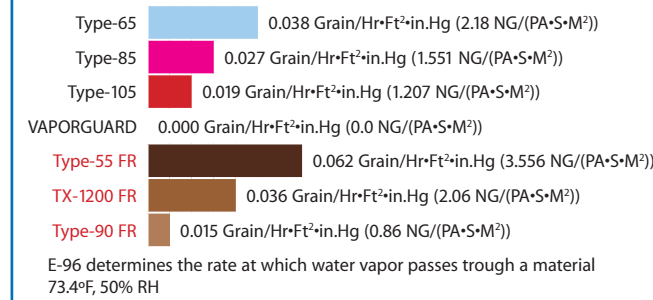

ASTM D-1709 / Puncture Resistance

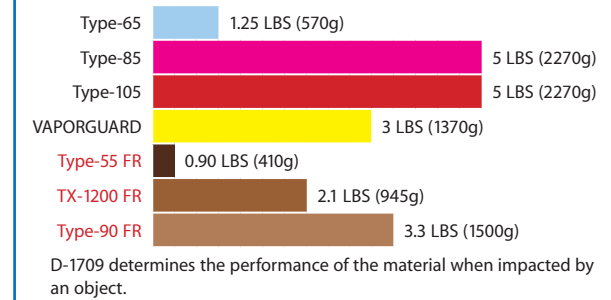

ASTM D-882 / 3" Tensile Strength

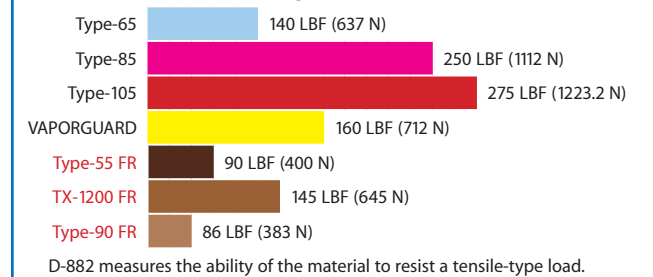

ASTM D-4833 / Puncture Strength

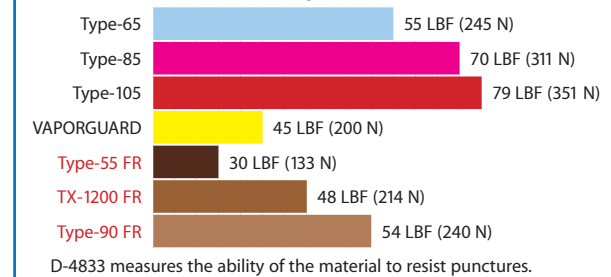

Concrete Curing Blankets

The American Concrete Institute (ACI) recommends maintaining satisfactory moisture content during concrete curing for best results. Lack of sufficient moisture may cause cracking, dusting, scaling and crazing.

- **Transguard® 2000** is a single use indoor/outdoor wet curing blanket engineered to help maintain optimal moisture during the concrete curing process.
- **Transguard® 4000** is a strong, lightweight, reusable, wet-cure blanket with a high water retention rate that helps maintain appropriate moisture levels during the concrete curing process. **Transguard® 4000** is manufactured of synthetic materials to avoid concrete staining common to other covers.

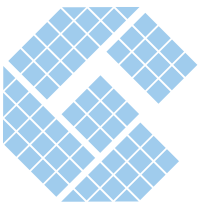

CRAWL SPACE APPLICATIONS

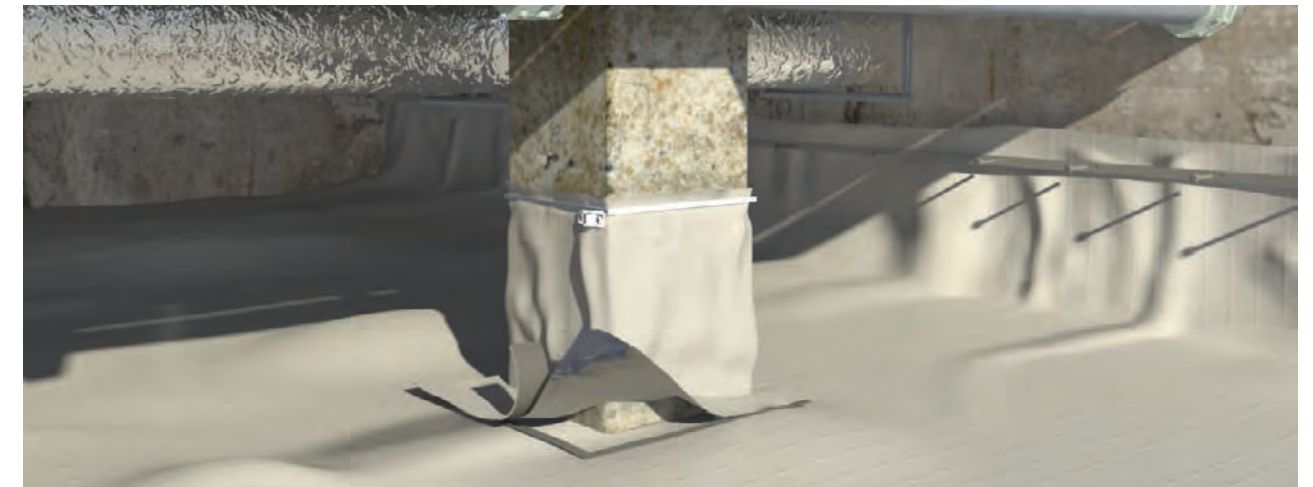
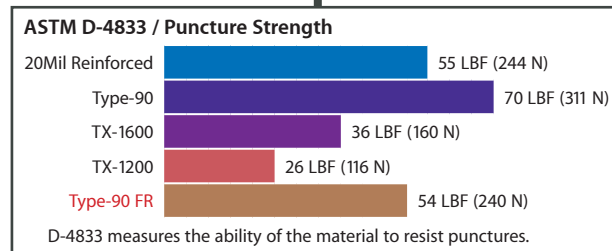
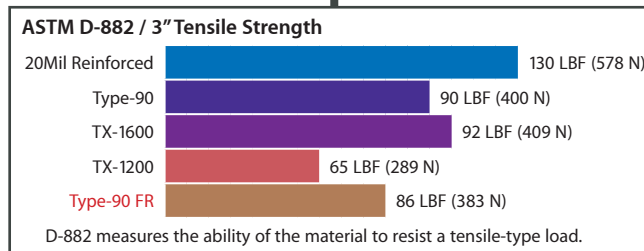
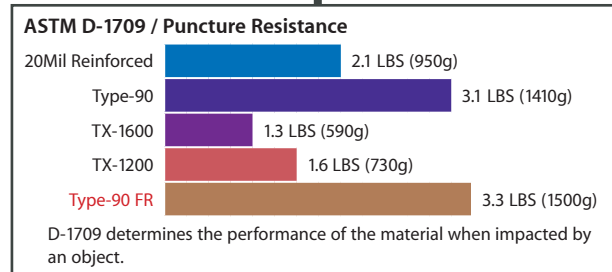
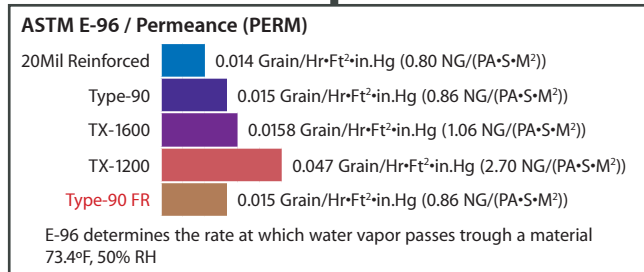
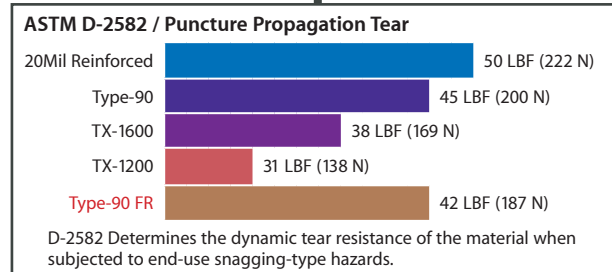
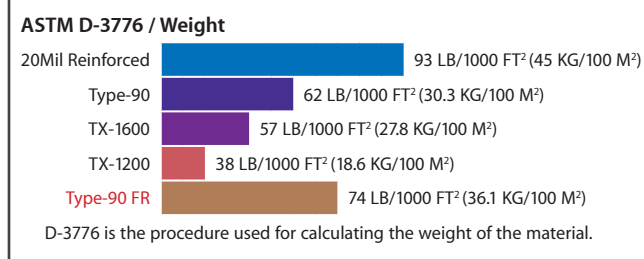

Crawl Space Solutions with the Griffolyn® System

Reef Industries' advanced technology products are designed to help maintain humidity levels in the crawl space for occupant comfort. The Griffolyn® System is performance engineered to control moisture and protect buildings from deterioration caused by moisture. Made from durable and strong, internally reinforced polyethylene laminates, the Griffolyn® System withstands extreme temperatures and is highly resistant to punctures and tears.

Surface Burning Characteristics

Griffolyn® Type-55 FR, TX-1200 FR and Type-90 FR pass NFPA 701 Large Scale "Standard Methods of Fire Tests for Flame-Resistant Textiles and Films." They have a Class A Flame Spread Rating per UBC-42 and ASTM E-84.

| Product | Flame Spread | Smoke Developed |
|-------------|--------------|-----------------|
| Type-55 FR | 10 | 70 |
| TX-1200 FR | 10 | 45 |
| Type-90 FR* | 5 | 135 |

* Class II / Class B



Standard Specification for Water Vapor Retarders Used in Contact with Soil or Granular Fill Under Concrete Slabs

"ASTM E-1745-09 REQUIREMENTS"

| Criteria | Test Method | Class A | Class B | Class C |
|-----------------------|----------------------|-------------|------------|-------------|
| Water Vapor Permeance | ASTM E-96 | 0.1 perms | 0.1 perms | 0.1 perms |
| Tensile strength | ASTM D-882 | 45.0 lbf/in | 30 lbf/in | 13.6 lbf/in |
| Puncture Resistance | ASTM D-1709 Method B | 2200 grams | 1700 grams | 475 grams |

"GRIFFOLYN® VAPOR RETARDER PERFORMANCE"

| Criteria | Test Method | 15 Mil Green | 10 Mil Green |
|-----------------------|----------------------|--------------|--------------|
| Classification | ----- | Class A | Class B |
| Water Vapor Permeance | ASTM E-96 | 0.018 perms | 0.027 perms |
| Tensile Strength | ASTM D-882 | 72 lbf | 44 lbf |
| Puncture Resistance | ASTM D-1709 Method B | 3178 grams | 2250 grams |

Antimicrobial additives in Griffolyn® Plastic Products

Reef Industries introduces the use of antimicrobial films and reinforced laminates that prevents the growth of harmful bacteria, fungi, mold and algae. The antimicrobial additive inhibits and/or kill bacteria, fungi and mildew where the prevention of microbial growth is critical.

1. Healthcare Facilities
2. Research Centers
3. Food Processing Plants
4. Commercial & Residential Crawl Spaces

Griffolyn®'s antimicrobial materials provide unique performance characteristics:

- Non-Migratory
- Wash Resistant
- Non-toxic and environmentally safe
- Durable and tear resistant
- Very Stable in a wide range of environments across a broad temperature range



9209 Almeda Genoa Rd. • Houston, Texas 77075

P: 713.507.4251

F: 713.507.4295

USA Toll Free: 1.800.231.6074

Mexico: 001.800.426.1447

E-mail: ri@reefindustries.com

Web: www.reefindustries.com • www.griffolyn.com



The information provided herein is based upon data believed to be reliable. All testing is performed in accordance with ASTM standards and procedures. All values are typical and nominal and do not represent either minimum or maximum performance of the product. Although the information is accurate to the best of our knowledge and belief, no representation of warranty or guarantee is made as to the suitability or completeness of such information. Likewise, no representation of warranty or guarantee, express or implied, or merchantability, fitness or otherwise, is made as to product application for a particular use.

CRITICAL VAPOR BARRIER APPLICATIONS: A Total System Approach

Provided by the Griffolyn Division of Reef Industries, Inc.

While vapor barriers are a prudent precaution on any project to avoid costly moisture infiltration problems, there are a number of project types where the implementation of a vapor barrier system is imperative. Some projects such as gymnasiums present a greater need for reliable moisture protection due to the delicate precision and high susceptibility to moisture damage of hardwood floor components. Others such as natatoriums, deanrooms and cold storage facilities create unique problems because of the high humidity and exaggerated differences in temperature and vapor pressure between the exterior and interior. In addition, environmental conditions such as a high water table or climate can produce moisture infiltration worries if the building is not protected by a properly installed vapor barrier system. The three primary characteristics to consider when specifying a vapor barrier for critical applications are permeance, strength & durability and efficiency of installation.

The amount of moisture vapor that can pass through the membrane (permeance) is especially important in applications where there will be a substantial interior/exterior difference in temperature, humidity or vapor pressure. Many "solid" building materials such as wood, brick, concrete or gypsum board offer little moisture protection due to their porous nature and require vapor barriers in such critical applications.

Without proper installation, the permeance and strength of the material are of little consequence. Moisture will flow through gaps in seams and around pipe penetrations just as readily as it does through tears in the membrane.

Griffolyn® reinforced vapor barriers utilize a total system approach to providing effective protection against moisture infiltration. There are several levels of permeance to choose from to meet the specific project demands for roofing, wall & ceiling and underslab applications. The high strength of the Griffolyn® reinforced membrane helps ensure that field performance is consistent with the lab-tested perm rating. The strength of the total system approach is most evident in the installation process. The most effective way to minimize moisture transmission through leaking field seams is to eliminate the seams altogether. Griffolyn® vapor barriers are custom manufactured to fit almost any job with a single membrane.

In cases where the job site is irregularly shaped or too large to make a single membrane practical, the multiple membranes can be easily and effectively sealed together with Fab Tape. This is a specially formulated sealing material that ensures an effective water and vapor tight system.

Almost every construction site has pipes and other obstructions that must penetrate the vapor barrier. Often a hole is simply cut in the membrane to allow the pipe to pass through the material. Water vapor can also pass through if the hole is left unsealed. The Griffolyn® vapor barrier system provides



The high susceptibility of hardwood floors to moisture damage can be offset through the proper installation of a vapor barrier system under the slab.



The effects of high humidity and exaggerated differences in interior/exterior vapor pressures associated with indoor pools can be controlled with an effective vapor barrier system.

specially designed pipe boots to effectively seal around every penetration in the material.

Reef Industries, Inc., has been manufacturing and fabricating specialized industrial plastics since 1957. Reef is taking a proactive role in the architectural industry by working with ASTM and ACI committees to help bring meaningful standards to this historically fragmented industry. In addition, the R&D department is constantly working on ways to incorporate the latest technological advances with time-tested manufacturing methods to produce innovative materials. All Griffolyn® membranes are tested annually using current ASTM and other regulated testing methods to provide architects with the most accurate data for specifying vapor barriers. Reef Industries will continue to produce high quality vapor barrier systems and provide architects with technical information and assistance in product selection and specification. Call 800/231-6074, extension 262C for answers to your questions about your critical applications.

Don't puncture the vapor retarder

Even small holes increase water-vapor emissions

By **BRUCE A. SUPRENT AND WARD R. MALISCH**

Specifiers often require concrete floors to be placed directly on a vapor retarder to reduce inflow of moisture from the subgrade soil and provide long-term protection for moisture-sensitive floor coverings. Water-vapor emissions as high as 100 pounds/1,000 square feet/24 hours have been measured over soils (Ref.1).

Covering the subgrade with a vapor retarder can help reduce emission rates from concrete-floor surfaces to the 3 or 5 lbs/1,000 sf/24 hrs typically required by floor-covering installers. But what happens if the vapor retarder is punctured or installed incorrectly? (See "Sources of Vapor-Retarders Leaks.") To answer this question, The Aberdeen Group performed calcium-chloride cup test on vapor retarders with and without holes.

Test setup and procedure

We performed the calcium-chloride cup tests over intact and punctured vapor retarders placed over a sand subbase at two moisture contents. We also varied vapor-retarder thickness and the size of the punctures.

Technicians placed ASTM C 33 concrete sand in twelve 16-inch-diameter, 3/4-inch-deep metal pans. To simulate saturated sand, they poured water into eight of the pans until the water level was visible just below the top of the pan. They weighed the sand in the other four pans and added 8% water by weight to simulate a typical optimum moisture content for a granular subbase.

The technicians covered four of the saturated-sand samples with 8-mil-thick polyethylene sheeting and the other four with 40-mil-thick polyethylene, using duck tape to secure the overhanging sides to the pan and prevent moisture loss. They used a similar procedure to cover the four pans containing lower-moisture-content sand with an 8-mil-thick polyethylene sheet.

Figure 1 shows the test setup, and Table 1 shows the test condition of the vapor retarder. In each of the three sets of four pans, one vapor retarder was intact, one had

a 1/8-inch-diameter nail hole, one had a 5/8-inch-diameter stake hole and one had an opening cut to the size of the lid for the calcium-chloride test kit.

Technicians measured water-vapor emission rates for all 12 specimens, using calcium-chloride cup test kits that were left in place three days. After the first test, the filled pans were stored in the laboratory for

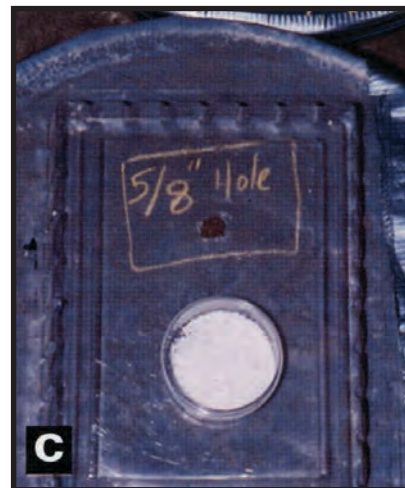
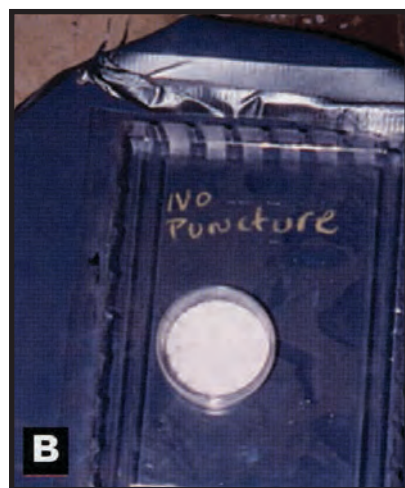

Figure 1. To measure water-vapor emissions through holes in the vapor retarder, eight pans filled with wet sand (photo A) were covered with 8-mil polyethylene sheeting (white) and four pans with 40-mil polyethylene (gray). Polyethylene covering three of the pans on the right had openings cut to size of the lid for the vapor-emission test kit. As shown in photo B, emission rate from the uncovered sand was measured with the calcium-chloride cup placed directly on the sand. Photo C shows a test kit mounted of a 5/8-inch-diameter hole in the polyethylene covering.

about 10 weeks and then retested for vapor emissions. For the retest, no additional water was added to the sand.

Significant emissions through stake holes

Table 1 also shows the water-vapor emission rates for each initial test and retest. The emission rate through the vapor retarders with no holes averaged 0.36 lb/1,000 sf/24 hrs, and

the results appear to indicate a higher emission rate through the thicker vapor retarder. However, we have conducted many calcium-chloride cup tests, and our experience doesn't support a conclusion that reducing the vapor-retarder thickness reduces vapor-emission rate. We believe the measured differences in emission rates over the intact vapor retarders more likely reflect a high test-precision error relative to the low emission rates that were measured.

A 1/8-inch-diameter nail hole allowed an average emission rate of 1.3 lbs/1,000 sf/24 hrs, and a 5/8-inch-diameter stake hole increased the average emission rate to 3 lbs/1,000 sf/24 hrs. Stake holes of this size could conceivably cause localized floor-covering failures or delay floor-covering installation, since a 3-pound rate is often the maximum allowed for installation of moisture-sensitive floor coverings.

The measured water-vapor emission rate through the lid-sized opening was about the same regardless of the moisture content, and the rate didn't decrease after more than two months of drying. In the field this means that when concrete is placed on a granular layer that is above a vapor retarder, any trapped moisture—weather from rain, workers sprinkling the layer or compaction—will provide a significant amount of moisture to the concrete slab.

After the retests were completed, we measured the moisture content of the sand in the three pans with lid-sized opening in the polyethylene. The moisture contents of the saturated sand were 18.8% and 15.6% for the 8-mil and 40-mil polyethylene, respectively, while the moisture content of the 8% sand had dropped to 2.5%. Surprisingly, even the granular base with 2.5% moisture content emitted water vapor at about the same rate as the wetter subbases. However, the measured values were much lower than the maximum soil emission values cited in Reference 1.

Comparison with other vapor-retarder test results

Our results showing the effect of intact vapor retarders are similar to those from earlier tests by Brewer (Ref.3). He measured moisture inflow from the subbase into 4-inch-thick concrete specimens with a water-cement ratio of 0.70 and placed directly on:

- Compacted clay
- Compacted clay covered with a gravel layer

Table 1 Moisture-emission test results (lbs/1,000 sf/24 hrs)

| Initial test | | | | |
|----------------------|--------------|-----------|-------------|---------|
| Date tested: | 04/11/98 | 04/11/98 | 04/11/98 | |
| Plastic thickness: | 8 mil | 40 mil | 8 mil | |
| Sand moisture: | saturated | saturated | 8% moisture | |
| Relative humidity: | 32% | 32% | 32% | |
| Temperature: | 70°F | 70°F | 70°F | |
| Test condition | | | | Average |
| No holes | 0.3 | 0.7 | 0.4 | 0.5 |
| Nail hole — 1/8 in. | 1.1 | 1.0 | 0.9 | 1.0 |
| Stake hole — 5/8 in. | 3.0 | 2.9 | 2.0 | 2.6 |
| Open sand | 8.9 | 9.4 | 8.8 | 9.0 |
| Retest | | | | |
| Date tested: | 06/22/98 | 06/22/98 | 06/22/98 | |
| Plastic thickness: | 8 mil | 40 mil | 8 mil | |
| Sand moisture: | saturated | saturated | 8% moisture | |
| Relative humidity: | 50% | 50% | 50% | |
| Temperature: | 72°F | 72°F | 72°F | |
| Test condition | | | | Average |
| No holes | 0.6 | 0.9 | 0.6 | 0.7 |
| Nail hole — 1/8 in. | 2.2 | 1.4 | 1.4 | 1.7 |
| Stake hole — 5/8 in. | 3.9 | 3.3 | 2.6 | 3.3 |
| Open sand | 11.4 | 12.5 | 11.4 | 11.7 |
| Summary | | | | |
| Test condition | Initial test | Retest | Average | |
| No holes | 0.5 | 0.7 | 0.6 | |
| Nail hole — 1/8 in. | 1.0 | 1.7 | 1.3 | |
| Stake hole — 5/8 in. | 2.6 | 3.3 | 3.0 | |
| Open sand | 9.0 | 11.7 | 10.4 | |

- Compacted clay covered with a vapor retarder

- Compacted clay covered with a gravel layer and vapor retarder.

He used two different vapor retarders: 4-mil polyethylene and 55-pound roofing felt. For details of his tests, see the article "Moisture Movement Through Concrete Slabs," *Concrete Construction*, November 1997, pp. 879-885.

Brewer started measuring moisture inflow about a month after the concrete had been placed. At this time, the inflow of concrete placed directly on compacted clay was about 20 lbs/1,000 sf/24 hrs. Inflow for the clay covered with vapor retarder was about 7 lbs/1,000 sf/24 hrs. Thus, an intact vapor retarder over a clay subgrade reduced moisture inflow by about 13 lbs/1,000 sf/24 hrs.

Inflow for concrete placed directly on a gravel layer over compacted clay was about 14 lbs/1,000 sf/24 hrs. Covering the clay and gravel with a vapor retarder had reduced inflow to about 6 lbs/1,000 sf/24 hrs. Thus, an intact vapor retarder over a gravel subbase reduced moisture inflow by about 8 lbs/1,000 sf/24 hrs, respectively.

Brewer's values are in the same range as our initial and retest values of about 9 and 11 lbs/1,000 sf/24 hrs, respectively, for intact vapor retarders placed over a wet sand sub-

base. Brewer wasn't able to detect vapor-emission differences between 4-mil polyethylene and 55-pound roofing felt, and we couldn't detect differences between 8-mil and 40-mil polyethylene.

Ensuring an effective vapor retarder

Because punctures or other openings in a vapor retarder can significantly increase water-vapor emissions through concrete floor slabs, specifiers should consider protective measures during the design process.

Some specifiers prefer a thick vapor retarder that will be more puncture-resistant during typical construction activities. Others require placement of a granular layer over the vapor retarder, specifying the use of a rounded gravel because angular crushed particles are more likely to puncture the vapor retarder. More cautions specifiers may require both a thicker vapor retarder and the placement of a rounded, granular layer over it. Whenever granular materials are placed over a vapor retarder, specifiers should be aware that a prolonged drying period may be needed if the granular materials get wet during building construction.

Contractors, too, must avoid damaging the vapor retarder. Some form manufacturers make supports for slab edge forms (Fig. 2) that don't

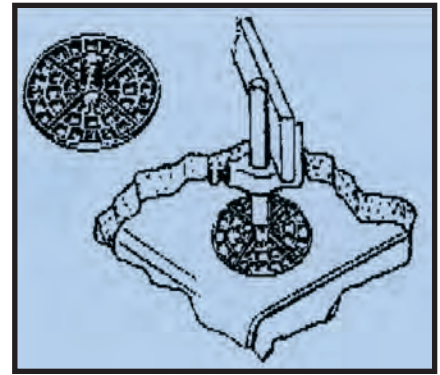

Figure 2. Pad-and-post supports for slab edge forms don't require puncturing the vapor retarder with a stake.

Dee Concrete Accessories Co., Div. of Tesko Enterprises

require puncturing the vapor retarder with stakes. Many contractors use job-built edge-form supports with wide bearing pads to avoid puncturing the plastic with edge-form stakes.

Finally, contractors must install the vapor retarder correctly by following manufacturers' instructions that usually require:

- Lapping joints and sealing them
- Sealing around all penetrations
- Lapping over footings, sealing to foundation walls, or both
- Protecting the vapor retarder during installation of reinforcing steel and utilities and during concrete placement
- Repairing any damage to the vapor retarder

References

1. Heinz R. Trechsel, editor, *Moisture Control in Buildings*, ASTM Manual Series: MNL 18, ASTM, West Conshohocken, Pa., 1994.
2. ASTM E 1643, "Standard Practice for installation of Water Vapor Retarders Used in Contact with Earth or Granular Fill Under Concrete Slabs," ASTM, 1994.
3. H.W. Brewer, "Moisture Migration—Concrete Slab-on-Ground Construction," *Journal of PCA Research and Development Laboratories*, Vol. 7, No. 2, Portland Cement Association, Skokie, Ill., May 1965.

Reprinted from the December 1998 issue of CONCRETE CONSTRUCTION.
© Hanley-Wood, LLC

Sources of vapor-retarder leaks

Through punctures caused by:

- Finishers poking holes in the vapor retarder so they can start work sooner. Because placing concrete directly on a vapor retarder instead of an absorptive base increases the bleeding period, some finishers do this to minimize delays.
- Workers puncturing the vapor retarder with stakes while placing edge forms and rebar supports.
- Vehicle traffic before and during the pour, which can rip the thin plastic sheets or cause underlying sharp aggregates to puncture them.

Through openings at:

- Unsealed edges along laps.
- Penetrations in the vapor retarder.
- Floor-wall joints. The vapor retarder should be pulled up at the sides and sealed to the footing or foundation wall, as recommended by Reference 2.

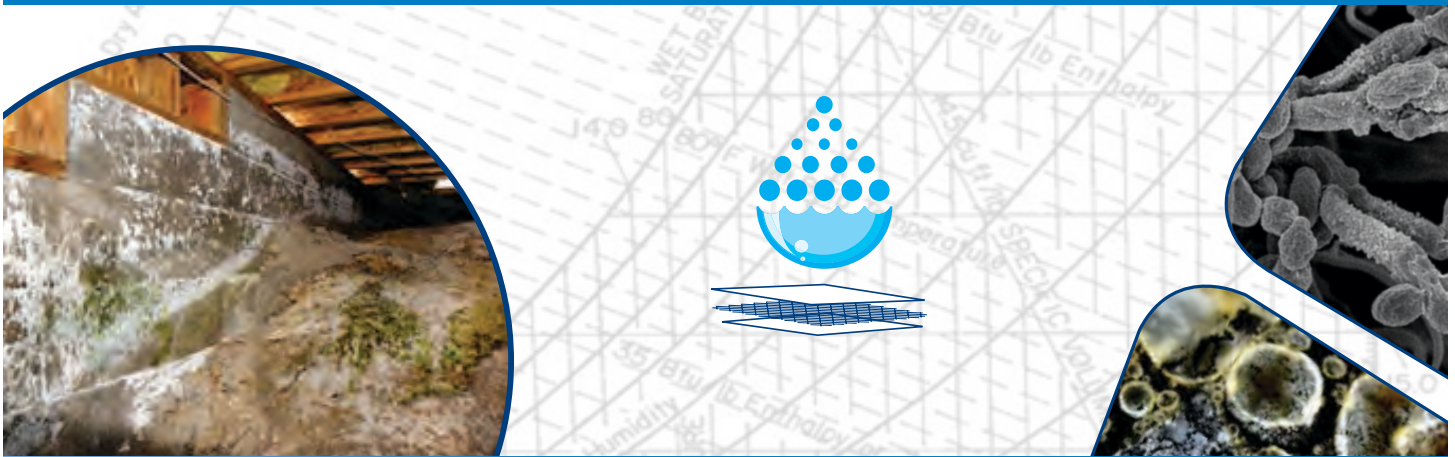

AVOID VAPOR RETARDER FAILURE WITH GRIFFOLYN[®] REINFORCED VAPOR RETARDERS

The majority of flooring failures result directly from a high emission of moisture from the crawl space.

It is said that moisture is the largest single problem in the flooring and coated surfaces industries today. Many of the vapor retarders installed under flooring systems do not perform adequately due to improper installation, placement, or puncturing.

Ineffective vapor retarders will not reduce permeability enough to control even the small amount of moisture it takes to interfere with the bond integrity of modern flooring systems.



6 mil Polyethylene Vapor Retarder Failure



Underslab view of another 6 mil polyethylene peeling away from the concrete slab

**CALL TODAY
FOR SPECIFICATIONS
AND YOUR PRICE QUOTE
1.800.231.6074
WWW.REEFINDUSTRIES.COM**



The following is a case study where 6 mil polyethylene was used as a vapor barrier and proved to be ineffective and very costly.

In 1990 two buildings were constructed in upstate New York. The preformed metal roofing system consisted of 22 ga. galvanized steel panels with 20 years paint finish, three inches of isocyanurate insulation, 6 mil polyethylene vapor barrier, and galvanized steel structural deck.

The building in question is a gymnasium building with no ceilings and is approximately 6 or 7 years old.

PROBLEM

After the building was approximately 1½ to 2 years old, severe leakage developed. Water was dripping from holes in the structural deck where screws holding down girts had missed their mark and had been removed or had their threads or base metal stripped. The problem was attributed to the vapor barrier. During the first and second winter the insulation was found to be completely saturated with water and frozen. Again this problem was attributed to moisture from within the building penetrating the faulty vapor barrier. A sample of the deteriorated

polyethylene vapor barrier that was removed from one of the buildings is shown.

When the roof was removed, they found the polyethylene vapor barrier to be torn over most of the area.

The leaking occurred only on sunny days during mid-winter until mid spring. The first roof was removed and the vapor barrier was found to be taped and in one case folded back on itself with no vapor protection.

A new vapor barrier was installed properly and the problems ended in 1993 - 1994. The second roof was partially checked in 1993 and only a small failure in installation was found and fixed. The area corresponded to 2/3 of the reported leaks. The following winter no leaks were reported. In the winter of 1994 - 1995 numerous leaks were reported, some in the same areas as before and a similar additional number in new areas. In 1994 - 1995 the owner commissioned an emergency contract to replace the roof system. What was found was a portion of the vapor barrier product in total failure. It was cracked, broken and discolored. It was so brittle it crumbled when touched.

SOLUTION

Install the Griffolyn® Vapor Barrier System and avoid the inconvenience and cost of untimely repairs. Made to last the life of the roof and resist thermally degrading, unlike the 6 mil polyethylene.

The Griffolyn® Systems perform in the extreme temperatures required of a roofing system. No other product line on the market can match the unique set of benefits, quality and performance.



9209 Almeda Genoa Rd.
Houston, Texas 77075

P: 713.507.4251

F: 713.507.4295

USA Toll Free: 1.800.231.6074

Mexico: 001.800.426.1447

E-mail: ri@reefindustries.com

www.reefindustries.com

www.griffolyn.com

TECHNICAL DATA SHEET

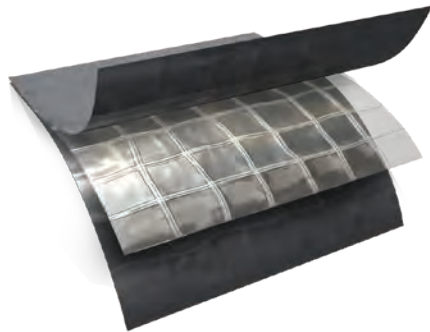

DESCRIPTION

Griffolyn® Type-65 is a 3-ply laminate combining two layers of high-density polyethylene and a high-strength cord grid. The non-woven cord grid provides a uniform loading resistance. It is specifically engineered to provide high strength and durability in a lightweight material.

PHYSICAL PROPERTIES AND TYPICAL VALUES

| PROPERTY | ASTM TEST METHOD | U.S. VALUE | METRIC VALUE |
|----------------------|------------------|---------------------------------------|--------------------------------|
| Weight | D-751 | 41.5 LB/1000 FT ² | 20.3 KG/100 M ² |
| 3" Tensile Strength | D-882 | 140 LBF | 6637 N |
| Puncture Strength | D-4833 | 55 LBF | 245 N |
| PPT Resistance | D-2582 | 42 LBF | 187 N |
| Dart Impact Strength | D-1709 | 1.25 LBS | 570 g |
| Cold Impact Strength | D-1790 | -40°F | -40°C |
| Permeance | E-96 | 0.038 Grain/Hr•Ft ² •In.Hg | 2.18 NG/(PA•S•M ²) |

Class C, ASTM E-1745-11 Standard Specification for Water Vapor Retarders Used in Contact With Soil or Granular Fill Under Concrete Slabs.

FEATURES AND BENEFITS

- Multiple layers and cord reinforcement resists tears.
- UV stabilization protects the material from degradation during extended exposure to sunlight.
- Cold-crack resistance eliminates failures in extremely cold temperatures.
- Chemically resistant to withstand exposure without significant deterioration.
- Low permeability greatly inhibits moisture transmission.
- Flexibility and light weight allow for easy handling and quick installation.
- Custom fabrication is available to meet your exact specifications.
- High durability allows for significant savings through reuse and fewer replacements.

MORE ▶▶

OUR CUSTOMERS DON'T JUST *cover their business,*
▶ THEY PROTECT IT



SUGGESTED APPLICATIONS

- Architectural vapor retarder for underslab, in walls & ceilings and in roofing systems.
- Pallet, cable reel and drum covers for outside storage.
- Floor covers, dust partitions and cleanroom enclosures.
- Temporary walls, plant dividers, building enclosures and containment tents.
- Shipping container covers and liners.
- Soil covers to control leachate for stockpiles and landfills.
- Erosion control and slope protection covers.

ORDERING INFORMATION

AVAILABLE COLORS:

Black

SIZES:

Rolls are available from 4' x 100' to 40' x 100' in increments of 4' widths. Some sizes available for immediate shipment. Standard length and width tolerances are $\pm 1\%$ (minimum 2")

Custom sizes up to 120' x 200' and custom fabrication are available to meet your exact specifications.

USABLE TEMPERATURE RANGE:

Minimum: -25°F -31.6°C

Maximum: 170°F 77°C

OUTDOOR EXPOSURE

Under normal continuous exposure the average life expectancy ranges from 18 to 30 months, depending on color.



REEF INDUSTRIES, INC.

9209 Almeda Genoa Rd. • Houston, Texas 77075

P: 713.507.4251 • F: 713.507.4295

E-mail: ri@reefindustries.com • www.reefindustries.com

TOLLFREE 1.800.231.6074

The information provided herein is based upon data believed to be reliable. All testing is performed in accordance with ASTM standards and procedures. All values are typical and nominal and do not represent either minimum or maximum performance of the product. Although the information is accurate to the best of our knowledge and belief, no representation of warranty or guarantee is made as to the suitability or completeness of such information. Likewise, no representation of warranty or guarantee, expressed or implied, or merchantability, fitness or otherwise, is made as to product application for a particular use.

TECHNICAL DATA SHEET

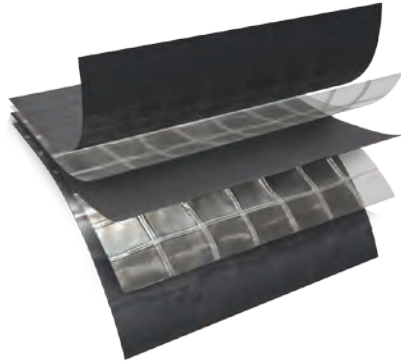

DESCRIPTION

Griffolyn® Type-85 is a 5-ply laminate combining three layers of high density polyethylene and two high-strength cord grids. It is specifically engineered to provide high strength and durability in a lightweight material.

PHYSICAL PROPERTIES AND TYPICAL VALUES

| PROPERTY | ASTM TEST METHOD | U.S. VALUE | METRIC VALUE |
|----------------------|------------------|---------------------------------------|---------------------------------|
| Weight | D-3776 | 70 LB/1000 FT ² | 34.2 KG/100 M ² |
| 3" Tensile Strength | D-882 | 250 LBF | 1112 N |
| Puncture Strength | D-4833 | 70 LBF | 311 N |
| PPT Resistance | D-2582 | 60 LBF | 267 N |
| Dart Impact Strength | D-1709 | 5 LBS | 2270 g |
| Cold Impact Strength | D-1790 | -60°F | -51°C |
| Permeance | E-96 | 0.027 Grain/Hr•Ft ² •in.Hg | 1.551 NG/(PA•S•M ²) |

Class B, ASTM E-1745-11 Standard Specification for Water Vapor Retarders Used in Contact With Soil or Granular Fill Under Concrete Slabs.

FEATURES AND BENEFITS

- Multiple layers and cord reinforcement resists tears.
- UV stabilization protects the material from degradation during extended exposure to sunlight.
- Cold-crack resistance eliminates failures in extremely cold temperatures.
- Chemically resistant to withstand exposure without significant deterioration.
- Low permeability greatly inhibits moisture transmission.
- Flexibility and light weight allow for easy handling and quick installation.
- Custom fabrication is available to meet your exact specifications.
- High durability allows for significant savings through reuse and fewer replacements.

MORE ▶▶

OUR CUSTOMERS DON'T JUST *cover their business,*
▶ THEY PROTECT IT



SUGGESTED APPLICATIONS

- Pallet, cable reel and drum covers for outside storage.
- Floor covers, dust partitions and cleanroom enclosures.
- Temporary walls, plant dividers, building enclosures and containment tents.
- Architectural vapor retarder for underslab, walls & ceilings and in roofing systems.
- Shipping container covers and liners.
- Soil covers to control leachate for stockpiles and landfills.
- Erosion control and slope protection covers.
- Agricultural storage systems, hay covers and windbreaks.
- Athletic field and equipment covers.

ORDERING INFORMATION

AVAILABLE COLORS:

Black

SIZES:

Rolls are available from 4' x 100' to 40' x 100' in increments of 4' widths. Some sizes available for immediate shipment. Standard length and width tolerances are $\pm 1\%$ (minimum 2")

Custom sizes up to 150' x 200' and custom fabrication are available to meet your exact specifications.

USABLE TEMPERATURE RANGE:

Minimum: -40°F -40°C

Maximum: 170°F 77°C

OUTDOOR EXPOSURE

Under normal continuous exposure the average life expectancy ranges from 36 to 48 months.



REEF INDUSTRIES, INC.

9209 Almeda Genoa Rd. • Houston, Texas 77075

P: 713.507.4251 • F: 713.507.4295

E-mail: ri@reefindustries.com • www.reefindustries.com

TOLLFREE 1.800.231.6074

The information provided herein is based upon data believed to be reliable. All testing is performed in accordance with ASTM standards and procedures. All values are typical and nominal and do not represent either minimum or maximum performance of the product. Although the information is accurate to the best of our knowledge and belief, no representation of warranty or guarantee is made as to the suitability or completeness of such information. Likewise, no representation of warranty or guarantee, expressed or implied, or merchantability, fitness or otherwise, is made as to product application for a particular use.

TECHNICAL DATA SHEET

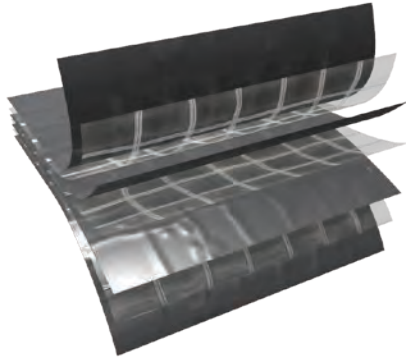

DESCRIPTION

Griffolyn® Type-105 is a 7-ply laminate combining four layers of high density polyethylene and three high-strength cord grids. It is specifically engineered to provide high strength and durability in a lightweight material.

PHYSICAL PROPERTIES AND TYPICAL VALUES

| PROPERTY | ASTM TEST METHOD | U.S. VALUE | METRIC VALUE |
|----------------------|------------------|---------------------------------------|---------------------------------|
| Weight | D-3776 | 90 LB/1000 FT ² | 44 KG/100 M ² |
| 3" Tensile Strength | D-882 | 275 LBF | 1223.2 N |
| Puncture Strength | D-4833 | 79 LBF | 351 N |
| PPT Resistance | D-2582 | 62 LBF | 270 N |
| Dart Impact Strength | D-1709 | 5.0 LBS | 2300 g |
| Cold Impact Strength | D-1790 | -40°F | -40°C |
| Permeance | E-96 | 0.019 Grain/Hr•Ft ² •in.Hg | 1.207 NG/(PA•S•M ²) |

FEATURES AND BENEFITS

- Multiple layers and cord reinforcement resist punctures and tears.
- UV stabilization protects the material from degradation during extended exposure to sunlight.
- Cold-crack resistance eliminates failures in extremely cold temperatures.
- Chemically resistant to withstand exposure without significant deterioration.
- Low permeability greatly inhibits moisture transmission.
- Flexibility & light weight allow for easy handling and quick installation.
- High durability allows for significant savings through reuse and fewer replacements.
- Class A, ASTM E-1745-11 Standard Specification for Water Vapor Retarders Used in Contact With Soil or Granular Fill Under Concrete Slabs.

MORE ▶▶

OUR CUSTOMERS DON'T JUST *cover their business,*
▶ THEY PROTECT IT



SUGGESTED APPLICATIONS

- Prairie dog barriers.
- Pallet, cable reel and drum covers for outside storage.
- Floor covers, dust partitions and cleanroom enclosures.
- Temporary walls, plant dividers, building enclosures and containment tents.
- Architectural vapor retarder for underslab, walls & ceilings and in roofing systems.
- Shipping container covers and liners.
- Soil covers to control leachate for stockpiles and landfills.
- Erosion control and slope protection covers.
- Agricultural storage systems, hay covers and windbreaks.
- Athletic field and equipment covers.

ORDERING INFORMATION

AVAILABLE COLORS:

Black

SIZES:

Rolls are available from 4' x 100' to 40' x 100' in increments of 4' widths. Some sizes available for immediate shipment. Standard length and width tolerances are $\pm 1\%$ (minimum 2")

Custom sizes up to 100' x 200' and custom fabrication are available to meet your exact specifications.

USABLE TEMPERATURE RANGE:

Minimum: -45°F -42°C

Maximum: 170°F 77°C

OUTDOOR EXPOSURE

Under normal continuous exposure the average life expectancy ranges from 30 to 48 months.



REEF INDUSTRIES, INC.

9209 Almeda Genoa Rd. • Houston, Texas 77075

P: 713.507.4251 • F: 713.507.4295

E-mail: ri@reefindustries.com • www.reefindustries.com

TOLLFREE 1.800.231.6074

The information provided herein is based upon data believed to be reliable. All testing is performed in accordance with ASTM standards and procedures. All values are typical and nominal and do not represent either minimum or maximum performance of the product. Although the information is accurate to the best of our knowledge and belief, no representation of warranty or guarantee is made as to the suitability or completeness of such information. Likewise, no representation of warranty or guarantee, expressed or implied, or merchantability, fitness or otherwise, is made as to product application for a particular use.

TRANSGUARD® 4000

REUSABLE CONCRETE CURING COVERS

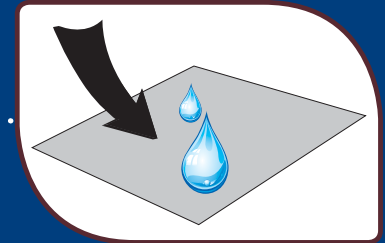

Using a hose, spray sufficient water on and around the area that will be covered with Transguard® 4000.

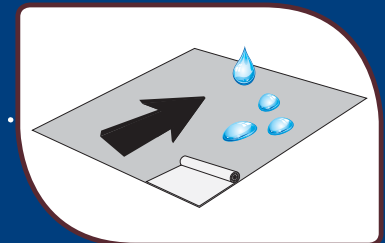

Place the Transguard® 4000 roll on the wet concrete floor, absorbent fiber side down, and unroll the blanket in a straight line.

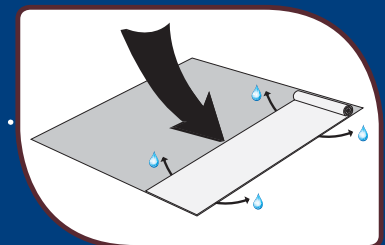

Smooth out any wrinkles and air pockets.

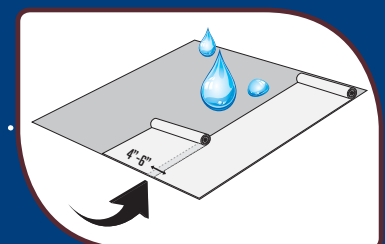

After watering the surface again, roll out the next layer of Transguard® 4000, making sure there is at least 4" - 6" overlap.

INSTALLATION

PRODUCT DESCRIPTION

Transguard® 4000 Concrete Curing Covers are engineered to help maintain optimal moisture during the concrete curing process.

Covers combine unpigmented non-woven polypropylene fabric to help maintain moisture with a white polyethylene membrane to minimize heat and limit evaporation.

The lightweight, flexible and reusable covers result in easy installations, saving time, labor and money.

To help maintain moisture, minimize heat gain and limit evaporation Transguard® 4000 complies with ASTM C-171, "Standard Specifications for Sheet Materials for Curing Concrete" for reflectance and moisture retention.

ADVANTAGES & PROPERTIES

- Allows for light traffic during curing process.
- Synthetic non-woven fabric will not mildew.
- Does not produce brown stains.
- D.O.T. approved in most states.
- Reusable.
- Contains ultra violet light stabilizers to protect against UV degradation.
- Low permeability.
- Can be used indoors or outdoors.

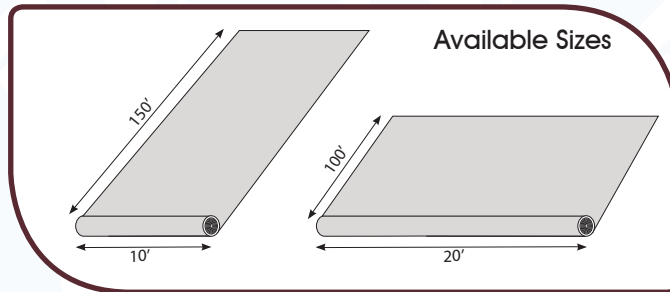

TOLLFREE 1.800.231.6074

9209 Alameda Genoa Rd. • Houston, Texas 77075

P: 713.507.4251 • F: 713.507.4295

Email: ri@reefindustries.com • www.reefindustries.com

TRANSGUARD® 4000

REUSABLE SLAB FLOOR PROTECTION

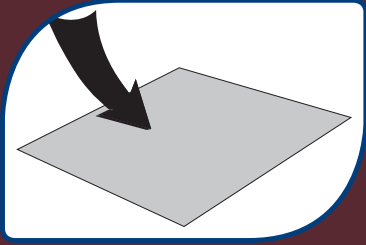

After 72 hours the concrete is placed, sweep floor of all debris.

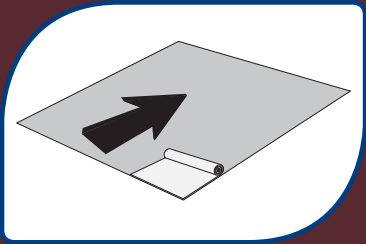

Place the Transguard® 4000 roll on the concrete floor, fiber side down, and unroll the blanket in a straight line.

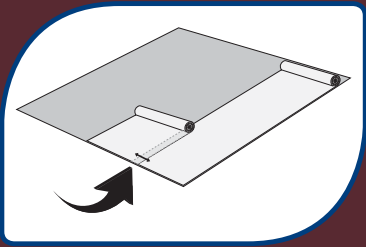

After the first layer has been rolled out, roll out the next layer of Transguard® 4000.



The seams are taped together using Griffolyn® White Pressure Sensitive Tape. Rolls are 4" wide x 50' in length.

INSTALLATION



PRODUCT DESCRIPTION

Temporarily protect concrete slabs from latent damage during construction and remediation projects with Transguard® 4000 concrete slab floor protection sheets. Damage to newly poured concrete or decorative colored floors caused by light construction traffic can be costly. Therefore, Transguard® 4000's ability to protect against light impact and liquid spills ensures concrete floors are safeguarded at a reasonable price.

Transguard® 4000 is a natural-colored polypropylene non-woven fabric with a white polyethylene backing that can be used to protect the surface of your concrete during light construction projects. This product does not produce brown stains or affect the appearance in the concrete if it happens to get wet.

ADVANTAGES & PROPERTIES

- High tear resistance.
- Easily Handled.
- Material is reusable.
- Allows for light traffic.
- White polyethylene coating applied to one side.
- Natural-colored polypropylene.
- Non-woven fabric will not mildew.
- Floor scratches and dings are minimized.
- Will not affect the appearance of the concrete.
- Will not produce brown stains if the cover gets wet.

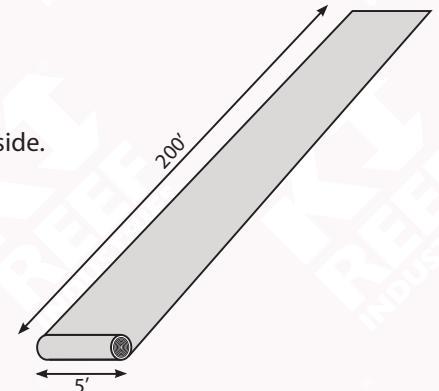

TECHNICAL DATA SHEET

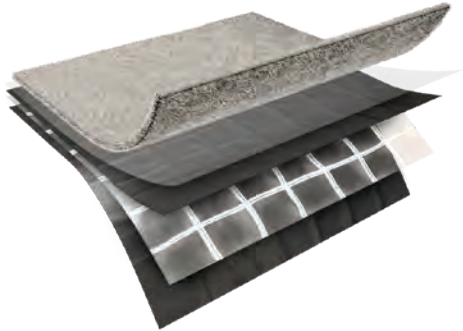

DESCRIPTION

Griffolyn® Type-65 G is a 3-ply laminate combining two layers of high density polyethylene and a high-strength cord grid with a layer of non-woven geotextile fiber. It is specifically engineered to provide high strength and durability in a lightweight material.

PHYSICAL PROPERTIES AND TYPICAL VALUES

| PROPERTY | ASTM TEST METHOD | U.S. VALUE | METRIC VALUE |
|----------------------|------------------|---------------------------------------|---------------------------------|
| Weight | D-3776 | 82 LB/1000 FT ² | 40.1 KG/100 M ² |
| 3" Tensile Strength | D-882 | 190 LBF | 845 N |
| Puncture Strength | D-4833 | 60 LBF | 267 N |
| PPT Resistance | D-2582 | 62 LBF | 276 N |
| Dart Impact Strength | D-1709 | 5 LBS | 2270 g |
| Cold Impact Strength | D-1790 | -40°F | -40°C |
| Permeance | E-96 | 0.038 Grain/Hr•Ft ² •In.Hg | 2.125 NG/(PA•S•M ²) |

FEATURES AND BENEFITS

- Multiple layers and cord reinforcement combined with the geotextile layer offer extremely high puncture and tear resistance.
- UV stabilization protects the material from degradation during extended exposure to sunlight.
- Cold-crack resistance eliminates failures in extremely cold temperatures.
- Low permeability greatly inhibits moisture transmission.
- Flexibility and light weight allow for easy handling and quick installation.
- Custom fabrication is available to meet your exact specifications.
- Class A, ASTM E-1745-11 Standard Specification for Water Vapor Retarders Used in Contact With Soil or Granular Fill Under Concrete Slabs.

MORE ▶▶

OUR CUSTOMERS DON'T JUST *cover their business,*
▶ THEY PROTECT IT



SUGGESTED APPLICATIONS

Architectural vapor retarder under slab on grade.

ORDERING INFORMATION

AVAILABLE COLORS:

Black

SIZES:

Rolls are available from 4' x 100' to 40' x 100' in increments of 4' widths. Some sizes available for immediate shipment. Standard length and width tolerances are $\pm 1\%$ (minimum 2")

Custom sizes up to 100' x 100' and custom fabrication are available to meet your exact specifications.

USABLE TEMPERATURE RANGE:

Minimum: -25°F -31.6°C

Maximum: 170°F 77°C

OUTDOOR EXPOSURE

Under normal continuous exposure the average life expectancy ranges from 18 to 30 months, depending on color.



REEF INDUSTRIES, INC.

9209 Almeda Genoa Rd. • Houston, Texas 77075

P: 713.507.4251 • F: 713.507.4295

E-mail: ri@reefindustries.com • www.reefindustries.com

TOLLFREE 1.800.231.6074

The information provided herein is based upon data believed to be reliable. All testing is performed in accordance with ASTM standards and procedures. All values are typical and nominal and do not represent either minimum or maximum performance of the product. Although the information is accurate to the best of our knowledge and belief, no representation of warranty or guarantee is made as to the suitability or completeness of such information. Likewise, no representation of warranty or guarantee, expressed or implied, or merchantability, fitness or otherwise, is made as to product application for a particular use.

TECHNICAL DATA SHEET

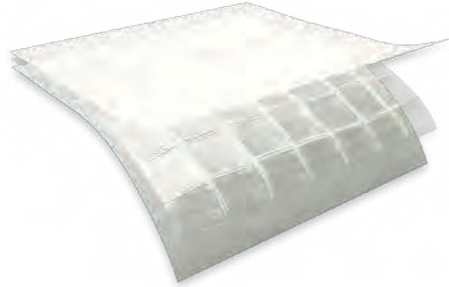

DESCRIPTION

Griffolyn® Type-55 FR is a 3-ply laminate combining two layers of fire retardant low density polyethylene and a high-strength cord grid. It is specifically engineered to provide high strength and durability in a lightweight material.

PHYSICAL PROPERTIES AND TYPICAL VALUES

| PROPERTY | ASTM TEST METHOD | U.S. VALUE | METRIC VALUE |
|----------------------|------------------|---------------------------------------|---------------------------------|
| Weight | D-3776 | 33 LB/1000 FT ² | 16.1 KG/100 M ² |
| 3" Tensile Strength | D-882 | 90 LBF | 400 N |
| 3" Load @ Break | D-882 | 36 LBF | 160 N |
| | | 2000 PSI | 13.8 MPA |
| Tongue Tear | D-751 B | 14 LBF | 62 N |
| Trapezoidal Tear | D-4533 | 26 LBF | 116 N |
| PPT Resistance | D-2582 | 26 LBS | 116 N |
| Dart Impact Strength | D-1709 | 0.90 LBS | 410 G |
| Cold Impact Strength | D-1790 | -20°F | -28.9°C |
| Permeance | E-96 | 0.062 Grain/Hr•Ft ² •In.Hg | 3.556 NG/(PA•S•M ²) |
| Fire Retardancy | E-84 | 5 flame spread, 35 smoke developed | |
| | NFPA 701 | Pass | |

FEATURES AND BENEFITS

- Fire retardant to meet safety requirements in critical equipment and material areas.
- Multiple layers and cord reinforcement resist punctures and tears.
- Cold-crack resistance eliminates failures in extremely cold temperatures.
- Low permeability greatly inhibits moisture transmission.
- Flexibility and light weight allow for easy handling and quick installation.
- Custom fabrication is available to meet your exact specifications.
- High durability allows for significant savings through reuse and fewer replacements.

MORE ▶▶

OUR CUSTOMERS DON'T JUST *cover their business,*
▶ THEY PROTECT IT



SUGGESTED APPLICATIONS

- Temporary walls, plant dividers, building enclosures and containment tents.
- Shipping container covers and liners.
- Floor covers, dust partitions and cleanroom enclosures.
- Bags and tubing (printing available).
- Industrial Packaging.
- Custom covers and outside storage.
- Architectural vapor retarder in walls, ceilings and in roofing systems.

ORDERING INFORMATION

AVAILABLE COLORS:

Natural, Yellow and Green

Custom sizes up to 100' x 125' and custom fabrication are available to meet your exact specifications.

USABLE TEMPERATURE RANGE:

Minimum: -5°F -20°C

Maximum: 150°F 66°C

OUTDOOR EXPOSURE

Under normal continuous exposure the average life expectancy ranges from 10 to 12 months, depending on color.

CONFORMS TO THE FOLLOWING SAFETY CODES:

- Passes NFPA 701 Test 2 (Large Scale) – “Standard Methods of Fire Tests for Flame Propagation of Textiles and Films”.
- Class I, Class A flame spread rating per UBC-42 and ASTM E-84.



REEF INDUSTRIES, INC.

9209 Almeda Genoa Rd. • Houston, Texas 77075

P: 713.507.4251 • F: 713.507.4295

E-mail: ri@reefindustries.com • www.reefindustries.com

TOLLFREE 1.800.231.6074

The information provided herein is based upon data believed to be reliable. All testing is performed in accordance with ASTM standards and procedures. All values are typical and nominal and do not represent either minimum or maximum performance of the product. Although the information is accurate to the best of our knowledge and belief, no representation of warranty or guarantee is made as to the suitability or completeness of such information. Likewise, no representation of warranty or guarantee, expressed or implied, or merchantability, fitness or otherwise, is made as to product application for a particular use.

TECHNICAL DATA SHEET

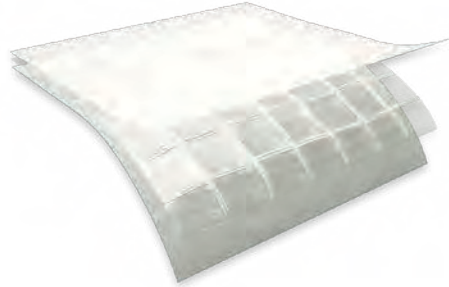

DESCRIPTION

Griffolyn® Type-55 ASFR is a 3-ply laminate combining two layers of antistatic fire retardant, linear low density polyethylene film and a high-strength cord grid. It is specifically engineered to provide antistatic fire retardant performance in a durable lightweight material.

PHYSICAL PROPERTIES AND TYPICAL VALUES

| PROPERTY | ASTM TEST METHOD | U.S. VALUE | METRIC VALUE |
|-----------------------------------|------------------------|---------------------------------------|--------------------------------|
| Weight | D-2103 | 32 LB/1000 FT ² | 15.6 KG/100 M ² |
| 3" Tensile Strength | D-882 | 87 LBF | 387 N |
| 3" Load @ Break | D-882 | 38 LBF | 169 N |
| | | 2100 PSI | 14.5 MPA |
| 3" Elongation @ Break | D-882 | 350 % | 350 % |
| Tongue Tear | D-751 B | 10.5 LBF | 47 N |
| PPT Resistance | D-2582 | 26 LBF | 116 N |
| Dart Impact Strength | D-1709 | 0.55 LBF | 250 G |
| Cold Impact Strength | D-1790 | -20°F | -28.9°C |
| Static Decay (50% RH, 10% cutoff) | NFPA-99 | 0.23 seconds | 0.23 seconds |
| Surface Resistivity | NFPA-99 | 2.8 x 10 ⁹ Ohms | 2.8 x 10 ⁹ Ohms |
| Fire Retardancy | E-84 | 10 flame spread, 75 smoke developed | |
| | NFPA 701 Test Method 2 | Pass | |
| Permeance | E-96 | 0.047 Grain/Hr•Ft ² •In.Hg | 2.71 NG/(PA•S•M ²) |

FEATURES AND BENEFITS

- Fire retardant to meet safety requirements in critical equipment and material areas.
- Multiple layers and cord reinforcement resist punctures and tears.
- Reduce enclosure wind whipping effect.
- Low permeability greatly inhibits moisture transmission.
- Flexibility and light weight allow for easy handling and quick installation.
- Custom fabrication is available to meet your exact specifications.
- High durability allows for significant savings through reuse and fewer replacements.
- Stock rolls available with imprint stating name, product fire retardancy and antistatic rating properties.

MORE ▶▶

OUR CUSTOMERS DON'T JUST *cover their business,*
▶ THEY PROTECT IT



SUGGESTED APPLICATIONS

- Temporary walls, plant dividers, building enclosures and containment tents.
- Shipping container covers and liners.
- Floor covers, dust partitions and cleanroom enclosures.
- Bags and tubing (printing available).
- Industrial packaging requiring antistatic protection
- Electronic areas
- Phone room/computer server room applications

ORDERING INFORMATION

AVAILABLE COLORS:

Natural

Custom sizes up to 100' x 200' and custom fabrication are available to meet your exact specifications.

USABLE TEMPERATURE RANGE:

Minimum: 0°F -18°C

Maximum: 170°F 77°C

OUTDOOR EXPOSURE

Under normal continuous exposure the average life expectancy ranges from 8 to 12 months.

CONFORMS TO THE FOLLOWING SAFETY CODES:

- Passes NFPA 701 Large Scale – “Standard Methods of Fire Tests for Flame-Propagation of Textiles and Films”.
- Class I, Class A flame spread rating per UBC-42 and ASTM E-84.
- Passes NFPA-99 for static decay.



REEF INDUSTRIES, INC.

9209 Almeda Genoa Rd. • Houston, Texas 77075

P: 713.507.4251 • F: 713.507.4295

E-mail: ri@reefindustries.com • www.reefindustries.com

TOLLFREE 1.800.231.6074

The information provided herein is based upon data believed to be reliable. All testing is performed in accordance with ASTM standards and procedures. All values are typical and nominal and do not represent either minimum or maximum performance of the product. Although the information is accurate to the best of our knowledge and belief, no representation of warranty or guarantee is made as to the suitability or completeness of such information. Likewise, no representation of warranty or guarantee, expressed or implied, or merchantability, fitness or otherwise, is made as to product application for a particular use.

TECHNICAL DATA SHEET

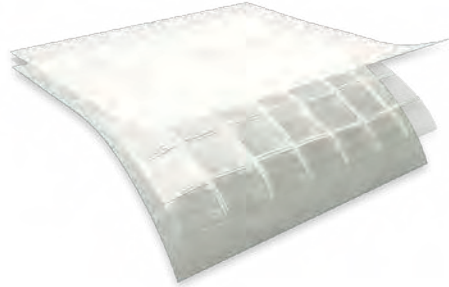

DESCRIPTION

Griffolyn® TX-1200 FR is a 3-ply laminate combining two layers of linear low density polyethylene and a high-strength cord grid. It is specifically engineered to provide high strength and durability in a lightweight material.

PHYSICAL PROPERTIES AND TYPICAL VALUES

| PROPERTY | ASTM TEST METHOD | U.S. VALUE | METRIC VALUE |
|----------------------|------------------|---------------------------------------|--------------------------------|
| Weight | D-3776 | 45 LB/1000 FT ² | 22 KG/100 M ² |
| 3" Tensile Strength | D-882 | 145 LBF | 645 N |
| Puncture Strength | D-4833 | 48 LBF | 214 N |
| PPT Resistance | D-2582 | 40 LBF | 178 N |
| Dart Impact Strength | D-1709 | 2.1 LBS | 945 g |
| Cold Impact Strength | D-1790 | -10°F | -23.4°C |
| Permeance | E-96 | 0.036 Grain/Hr•Ft ² •In.Hg | 2.06 NG/(PA•S•M ²) |
| Fire Retardancy | E-84 | 5 flame spread, 75 smoke developed | |
| | NFPA 701 | Pass | |

FEATURES AND BENEFITS

- Multiple layers and cord reinforcement resist punctures and tears.
- Cold-crack resistance eliminates failures in cold temperatures.
- Low permeability greatly inhibits moisture transmission.
- Flexibility and light weight allow for easy handling and quick installation.
- Custom fabrication is available to meet your exact specifications.
- Long life expectancy allows for significant cost savings through reuse and fewer replacements.

CONFORMS TO THE FOLLOWING SAFETY CODES:

- Passes NFPA 701 Test 2 (Large Scale) – “Standard Methods of Fire Tests for Flame Propagation of Textiles and Films”.
- Class I, Class A flame spread rating per UBC-42 and ASTM E-84.

MORE ▶▶

OUR CUSTOMERS DON'T JUST *cover their business,*
▶ THEY PROTECT IT



SUGGESTED APPLICATIONS

- Temporary walls, plant dividers, building enclosures and containment tents.
- Floor covers, dust partitions and cleanroom enclosures.
- Architectural vapor retarder in walls & ceilings and in roofing systems.
- Pallet, cask and drum covers for outside storage.
- Shipping container covers and liners.

ORDERING INFORMATION

AVAILABLE COLORS:

Natural and Yellow

Custom sizes up to 100' x 200' and custom fabrication are available to meet your exact specifications.

USABLE TEMPERATURE RANGE:

Minimum: -15°F -27°C

Maximum: 170°F 77°C

OUTDOOR EXPOSURE

Under normal continuous exposure the average life expectancy ranges from 10 to 12 months, depending on color.



REEF INDUSTRIES, INC.

9209 Almeda Genoa Rd. • Houston, Texas 77075

P: 713.507.4251 • F: 713.507.4295

E-mail: ri@reefindustries.com • www.reefindustries.com

TOLLFREE 1.800.231.6074

The information provided herein is based upon data believed to be reliable. All testing is performed in accordance with ASTM standards and procedures. All values are typical and nominal and do not represent either minimum or maximum performance of the product. Although the information is accurate to the best of our knowledge and belief, no representation of warranty or guarantee is made as to the suitability or completeness of such information. Likewise, no representation of warranty or guarantee, expressed or implied, or merchantability, fitness or otherwise, is made as to product application for a particular use.

TECHNICAL DATA SHEET

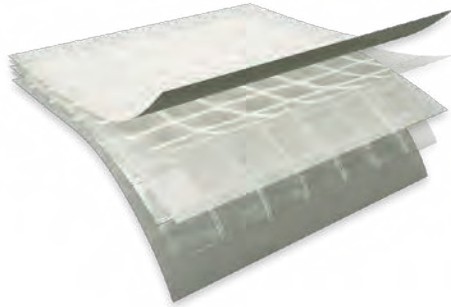

DESCRIPTION

Griffolyn® Type-90 FR is a 5-ply laminate combining three layers of fire retardant, linear low density polyethylene and two high-strength cord grids. It is specifically engineered to provide high strength and durability in a lightweight material.

PHYSICAL PROPERTIES AND TYPICAL VALUES

| PROPERTY | ASTM TEST METHOD | U.S. VALUE | METRIC VALUE |
|-----------------------|------------------|---------------------------------------|--------------------------------|
| Weight | D-3776 | 74 LB/1000 FT ² | 36.1 KG/100 M ² |
| 3" Tensile Strength | D-882 | 180 LBF | 801 N |
| 3" Load @ Break | D-882 | 86 LBF | 383 N |
| | | 2000 PSI | 13.8 MPA |
| 3" Elongation @ Break | D-882 | 375 % | 375 % |
| Tongue Tear | D-882 | 31 LBF | 138 N |
| Trapezoidal Tear | D-4533 | 50 LBF | 222 N |
| Puncture Strength | D-4833 | 54 LBF | 240 N |
| PPT Resistance | D-2582 | 42 LBF | 187 N |
| Dart Impact Strength | D-1709 | 3.3 LBS | 1500 g |
| Cold Impact Strength | D-1790 | -40°F | -40°C |
| Permeance | E-96 | 0.015 Grain/Hr•Ft ² •in.Hg | 0.86 NG/(PA•S•M ²) |
| Fire Retardancy | E-84 | 5 flame spread, 90 smoke developed | |
| | NFPA 701 | Pass | |

FEATURES AND BENEFITS

- Multiple layers and cord reinforcement resist punctures and tears.
- Flexibility and light weight allow for easy handling and quick installation.
- Custom fabrication is available to meet your exact specifications.
- Long life expectancy allows for significant cost savings through reuse and fewer replacements.

MORE ▶▶

OUR CUSTOMERS DON'T JUST *cover their business,*
▶ THEY PROTECT IT



CONFORMS TO THE FOLLOWING SAFETY CODES:

- Passes NFPA 701 Test 2 (Large Scale) – “Standard Methods of Fire Tests for Flame Propagation of Textiles and Films”.

SUGGESTED APPLICATIONS

- Temporary walls, plant dividers, building enclosures and containment tents.
- Architectural vapor retarders in walls, ceilings and roofing systems.
- Floor covers, dust partitions and cleanroom enclosures.
- Equipment covers.
- Pallet and custom covers for outside storage.
- Custom shipping container covers and liners.
- Environmental covers for waste containment and disposal.
- Industrial Packaging.

ORDERING INFORMATION**AVAILABLE COLORS:**

Natural and Green

Custom sizes up to 100' x 150' and custom fabrication are available to meet your exact specifications.

USABLE TEMPERATURE RANGE:

Minimum: -30°F -32°C

Maximum: 170°F 77°C

OUTDOOR EXPOSURE

Under normal continuous exposure the average life expectancy ranges from 10 to 12 months.

**REEF INDUSTRIES, INC.**

9209 Almeda Genoa Rd. • Houston, Texas 77075

P: 713.507.4251 • F: 713.507.4295

E-mail: ri@reefindustries.com • www.reefindustries.com

TOLLFREE 1.800.231.6074

The information provided herein is based upon data believed to be reliable. All testing is performed in accordance with ASTM standards and procedures. All values are typical and nominal and do not represent either minimum or maximum performance of the product. Although the information is accurate to the best of our knowledge and belief, no representation of warranty or guarantee is made as to the suitability or completeness of such information. Likewise, no representation of warranty or guarantee, expressed or implied, or merchantability, fitness or otherwise, is made as to product application for a particular use.



DESCRIPTION

Transguard® 4000 consists of a natural colored polypropylene nonwoven fabric with a white polyethylene coating applied to one side. The non perforated coating contains ultraviolet light stabilizers providing protection against UV degradation.

PHYSICAL PROPERTIES AND TYPICAL VALUES

| PROPERTY | ASTM TEST METHOD | U.S. VALUE | METRIC VALUE |
|--------------------------|------------------|-----------------------------|----------------------------|
| Weight | D-2103 | 42 Lbs/1000 FT ² | 20.5 KG/100 M ² |
| Thickness | D-5199 | 35 MIL | 0.9 mm |
| Grab Tensile | D-4632 | 95 Lbf | 422 N |
| Grab Elongation | D-4632 | 50 % | 50 % |
| Trapezoidal Tear | D-4533 | 34 Lbf | 151 N |
| Hydraulic Burst | D-3786 | 190 PSI | 1.3 Mpa |
| Water Loss (per 24 hrs.) | C-156 | 0.0016 Lbs/Ft ² | 8 gm/m ² |
| Reflectance | E-1347 | 85 % | 85 % |
| Puncture Strength | D-4833 | 65 Lbf | 289 N |

FEATURES AND BENEFITS

Transguard® 4000 Single Use Wet Cure Covers meet or exceed ASTM C-171, "Standard Specification for Sheet Materials for Curing Concrete" for moisture retention and reflection.

➔ THEY PROTECT IT



9209 Alameda Genoa Rd. • Houston, Texas 77075
 P: 713.507.4251 • F: 713.507.4295
 E-mail: ri@reefindustries.com • www.reefindustries.com

TOLLFREE 1.800.231.6074

The information provided herein is based upon data believed to be reliable. All testing is performed in accordance with ASTM standards and procedures. All values are typical and nominal and do not represent either minimum or maximum performance of the product. Although the information is accurate to the best of our knowledge and belief, no representation of warranty or guarantee is made as to the suitability or completeness of such information. Likewise, no representation of warranty or guarantee, expressed or implied, or merchantability, fitness or otherwise, is made as to product application for a particular use.

TECHNICAL DATA SHEET

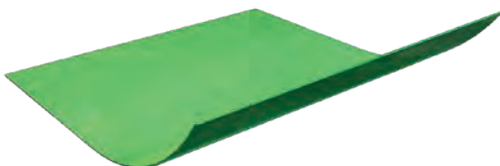

DESCRIPTION

Griffolyn® 10 mil is a co-extruded polyolefin membrane containing the latest polymer technology, resulting in superior puncture resistance, impact and tensile strength. It is specifically engineered to provide high strength and durability in a vapor retarder.

PHYSICAL PROPERTIES AND TYPICAL VALUES

| PROPERTY | ASTM TEST METHOD | U.S. VALUE | METRIC VALUE |
|-----------------------|------------------|---------------------------------------|---------------------------------|
| Roll Weight | D-2103 | 145 LBS | 67 KG |
| Roll Size | | 12' x 250' | 3.65 M x 76 M |
| 1" Load @ Break | D-882 | 44 LBF | 196 N |
| | | 4500 PSI | 31 MPA |
| 3" Elongation @ Break | D-882 | 600 % | 600 % |
| Tongue Tear | D-2261 | 12 LBF | 53 N |
| Dart Impact Strength | D-1709 | 5 LBS | 2250 g |
| Permeance | E-96 | 0.027 Grain/Hr•Ft ² •In.Hg | 1.549 NG/(PA•S•M ²) |
| PPT Resistnace | D-2582 | 36 LBF | 160 N |

FEATURES AND BENEFITS

- Class A and Class B, ASTM E-1745-2011 Standard Specification for Water Vapor Retarders Used in Contact With Soil or Granular Fill Under Concrete Slabs.
- Low permeability greatly inhibits moisture transmission.
- Flexibility allows for easy handling and quick installation.
- Cold-crack resistance eliminates failures in extremely cold temperatures.

OUR CUSTOMERS DON'T JUST *cover their business,*
➔ THEY PROTECT IT



REEF INDUSTRIES, INC.
 9209 Almeda Genoa Rd. • Houston, Texas 77075
 P: 713.507.4251 • F: 713.507.4295
 E-mail: ri@reefindustries.com • www.reefindustries.com

TOLLFREE 1.800.231.6074

The information provided herein is based upon data believed to be reliable. All testing is performed in accordance with ASTM standards and procedures. All values are typical and nominal and do not represent either minimum or maximum performance of the product. Although the information is accurate to the best of our knowledge and belief, no representation of warranty or guarantee is made as to the suitability or completeness of such information. Likewise, no representation of warranty or guarantee, expressed or implied, or merchantability, fitness or otherwise, is made as to product application for a particular use.

TECHNICAL DATA SHEET

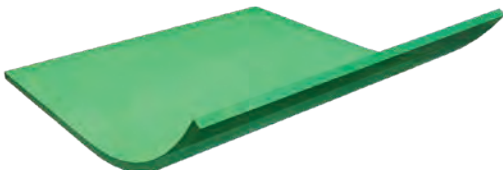

DESCRIPTION

Griffolyn® 15 mil is a co-extruded polyolefin membrane containing the latest polymer technology, resulting in superior puncture resistance, impact and tensile strength. It is specifically engineered to provide high strength and durability in a vapor retarder.

PHYSICAL PROPERTIES AND TYPICAL VALUES

| PROPERTY | ASTM TEST METHOD | U.S. VALUE | METRIC VALUE |
|-----------------------|------------------|--------------------------|--------------------|
| Roll Weight | D-2103 | 145 LBS | 67 KG |
| Roll Size | | 10' x 200' | 3 M x 61 M |
| 1" Load @ Break | D-882 | 72 LBF | 320 N |
| | | 4800 PSI | 33.1 MPA |
| 3" Elongation @ Break | D-882 | 600 % | 600 % |
| Tongue Tear | D-2261 | 24 LBF | 107 N |
| Dart Impact Strength | D-1709 | 7 LBS | 3178 g |
| Permeance | E-96 | 0.018 Grain/Hr•Ft²•in.Hg | 1.032 NG/(PA•S•M²) |
| PPT Resistnace | D-2582 | 47 LBF | 209 N |

FEATURES AND BENEFITS

- Class A and Class B, ASTM E-1745-2011 Standard Specification for Water Vapor Retarders Used in Contact With Soil or Granular Fill Under Concrete Slabs.
- Low permeability greatly inhibits moisture transmission.
- Flexibility allows for easy handling and quick installation.
- Cold-crack resistance eliminates failures in extremely cold temperatures.

OUR CUSTOMERS DON'T JUST *cover their business,*
➔ THEY PROTECT IT



REEF INDUSTRIES, INC.
 9209 Almeda Genoa Rd. • Houston, Texas 77075
 P: 713.507.4251 • F: 713.507.4295
 E-mail: ri@reefindustries.com • www.reefindustries.com

TOLLFREE 1.800.231.6074

The information provided herein is based upon data believed to be reliable. All testing is performed in accordance with ASTM standards and procedures. All values are typical and nominal and do not represent either minimum or maximum performance of the product. Although the information is accurate to the best of our knowledge and belief, no representation of warranty or guarantee is made as to the suitability or completeness of such information. Likewise, no representation of warranty or guarantee, expressed or implied, or merchantability, fitness or otherwise, is made as to product application for a particular use.

TECHNICAL DATA SHEET

DESCRIPTION

L20 Black is a high strength and durable membrane engineered to work in many environments. It is specifically engineered for liner and vapor barrier applications.

PHYSICAL PROPERTIES AND TYPICAL VALUES

| PROPERTY | ASTM TEST METHOD | U.S. VALUE | METRIC VALUE |
|--------------------------|------------------|---|---|
| Weight | D-2103 | 96.0 LB/1000 FT ² | 46.8 KG/100M ² |
| Thickness | D-2103 | 20 MIL | 0.51 MM |
| Density | D-1505 | 0.939 G/CC | 0.939 G/CC |
| 3" Load @ Break | D-882 | 260 LBF | 1156 N |
| | | 4300 PSI | 29.6 MPA |
| 3" Elongation @ Break | D-882 | 600 % | 600 % |
| Tongue Tear | D-2261 | 25 LBF | 111 N |
| Trapezoidal Tear | D-4533 | 46 LBF | 205 N |
| Puncture Strength | D-4833 | 45 LBF | 200 N |
| Dart Impact Strength | D-1709 | 5.0 LBS | 2220 g |
| Water Vapor Permeance | E-96 | 0.013 Grain/Hr•Ft ² •In.Hg | 0.72 NG/(PA•S•M ²) |
| Methane Permeability | D-1434, Method V | 3.15 x 10 ⁻⁴ m ³ /m ² /Day | 3.15 x 10 ⁻⁴ m ³ /m ² /Day |
| Carbon Black Content | D-1603 | 2 % | 2 % |
| Oxidative Induction Time | D-3895 | 100 Minutes | 100 Minutes |

OUR CUSTOMERS DON'T JUST *cover their business,*
 ➔ THEY PROTECT IT



REEF INDUSTRIES, INC.
 9209 Almeda Genoa Rd. • Houston, Texas 77075
 P: 713.507.4251 • F: 713.507.4295
 E-mail: ri@reefindustries.com • www.reefindustries.com

TOLLFREE 1.800.231.6074

The information provided herein is based upon data believed to be reliable. All testing is performed in accordance with ASTM standards and procedures. All values are typical and nominal and do not represent either minimum or maximum performance of the product. Although the information is accurate to the best of our knowledge and belief, no representation of warranty or guarantee is made as to the suitability or completeness of such information. Likewise, no representation of warranty or guarantee, expressed or implied, or merchantability, fitness or otherwise, is made as to product application for a particular use.

TECHNICAL DATA SHEET

DESCRIPTION

L30 Black is a high strength and durable liner material engineered to work in many environments. It is specifically engineered for liner applications.

PHYSICAL PROPERTIES AND TYPICAL VALUES

| PROPERTY | ASTM TEST METHOD | U.S. VALUE | METRIC VALUE |
|--------------------------|------------------|--------------------------------------|--------------------------------|
| Weight | D-2103 | 148 LB/1000 FT ² | 72.2 KG/100M ² |
| Thickness | D-2103 | 30 MIL | 0.76 MM |
| Density | D-1505 | 0.939 G/CC | 0.939 G/CC |
| 3" Load @ Break | D-882 | 350 LBF | 1557 N |
| | | 3800 PSI | 26.2 MPA |
| 3" Elongation @ Break | D-882 | 225 % | 225 % |
| Tongue Tear | D-1004 | 50 LBF | 222 N |
| Trapezoidal Tear | D-4533 | 66 LBF | 294 N |
| Permeance | E-96 | .013 Grain/Hr•Ft ² •in.Hg | 0.72 NG/(PA•S•M ²) |
| Dart Impact Strength | D-1709 | > 5.0 LBS | > 2200 g |
| Puncture Strength | D-4833 | 65 LBF | 289 N |
| Carbon Black Content | D-1603 | 2 % | 2 % |
| Oxidative Induction Time | D-3895 | 100 Minutes | 100 Minutes |

OUR CUSTOMERS DON'T JUST *cover their business,*
➔ THEY PROTECT IT



REEF INDUSTRIES, INC.
 9209 Almeda Genoa Rd. • Houston, Texas 77075
 P: 713.507.4251 • F: 713.507.4295
 E-mail: ri@reefindustries.com • www.reefindustries.com

TOLLFREE 1.800.231.6074

The information provided herein is based upon data believed to be reliable. All testing is performed in accordance with ASTM standards and procedures. All values are typical and nominal and do not represent either minimum or maximum performance of the product. Although the information is accurate to the best of our knowledge and belief, no representation of warranty or guarantee is made as to the suitability or completeness of such information. Likewise, no representation of warranty or guarantee, expressed or implied, or merchantability, fitness or otherwise, is made as to product application for a particular use.



WATER VAPOR TRANSMISSION DEFINITIONS AND CONVERSION FACTORS

Water Vapor Transmission Rate (WVTR)

The steady water vapor flow in unit time through unit area of a body, normal to specific parallel surfaces, under specific conditions of temperature and humidity at each surface.

$$WVT = G/tA$$

G = weight change; t = time; and A = surface area

$$\text{Units: grains / h} \cdot \text{ft}^2 \\ \text{G / h} \cdot \text{m}^2$$

Conversion factors

$$\text{Grains / h} \cdot \text{ft}^2 \times 0.697 = \text{g/h} \cdot \text{m}^2 \\ \text{g/h} \cdot \text{m}^2 \times 1.43 = \text{grains/h} \cdot \text{ft}^2$$

Water Vapor Permeance

The time rate of water vapor transmission through unit area of flat material or constructions induced by unit vapor pressure difference between two specific surfaces, under specified temperature and humidity conditions. Permeance is a performance evaluation of a material, not a property.

$$\text{Permeance} = WVT/Dp = WVT/S(R1-R2)$$

Dp = vapor pressure difference

S = saturation vapor pressure at test temperature

R1 = RH at the source R2 = at the vapor sink

$$\text{Units: 1 perm} = 1.00 \text{ grains/h} \cdot \text{ft}^2 \cdot \text{in Hg} \\ = 5.72\text{E-}08 \text{ g/Pa} \cdot \text{s} \cdot \text{m}^2 \\ = 2.74\text{E-}02 \text{ g/h} \cdot \text{m}^2 \cdot \text{mm Hg}$$

Conversion factors

$$\text{Perms} \times 5.72\text{E-}08 = \text{g/Pa} \cdot \text{s} \cdot \text{m}^2 \\ \text{G/Pa} \cdot \text{s} \cdot \text{m}^2 \times 1.75\text{E-}07 = \text{Perms} \\ \text{Mm Hg} = 1.333\text{E-}02 \text{ Pa}$$

Water Vapor Permeability

The time rate of water vapor transmission through unit area of a flat material of unit area induced by unit vapor pressure difference between two specific surfaces under specified temperature and humidity conditions. Permeability is a property of a material.

$$\text{Permeability} = \text{Permeance} \times \text{Thickness}$$

$$\text{Units Perm-inches} = \text{grains} \cdot \text{in/h} \cdot \text{ft}^2 \text{ in Hg} \\ = 6.88\text{E-}10 \text{ g/Pa} \cdot \text{s} \cdot \text{m}$$

Conversion Factors

$$\text{Perm-inches} \times 1.45\text{E-}08 = \text{g/Pa} \cdot \text{s} \cdot \text{m} \\ \text{G/Pa} \cdot \text{s} \cdot \text{m} \times 6.88\text{E-}10 = \text{Perm-inches}$$

TECHNICAL DATA SHEET



DESCRIPTION

Griffolyn® Double-Sided Bonding Tape consists of a solid low stretch core film coated on both sides with a clear synthetic rubber adhesive. A release liner is on one side of the structure.

PHYSICAL PROPERTIES AND TYPICAL VALUES

| PROPERTY | U.S. VALUE | METRIC VALUE |
|--------------------------------|--------------|-----------------|
| Overall Thickness | 15.9 Mils | .3975 MM |
| Adhesive and Carrier Thickness | 12.7 Mils | .3175 MM |
| Overall Width | 1.75 In. | 44.4 MM |
| Adhesive Width | 1.50 In. | 38.1 MM |
| Roll Length | 300 Ft. | 91.4 M |
| Roll Weight | 3.75 LBS | 1.7 KG |
| 180° Peel Adhesion | 150 oz/in | 1.64 N / MM |
| Application Temperature Range | 45°F - 105°F | 7°C - 40.6° C |
| Operating Temperature Range | 0°F - 140°F | -17.7°C - 60° C |

INSTALLATION

The surface to be taped should be clean and dry. The tape will not adhere if the surfaces are not properly prepared. Dirty or wet surfaces should be completely cleaned with water, paper towels, dry rags or other materials which will prepare the surface for the tape. Accumulations of dust should also be removed to insure a secure seam.

The product obtains optimum adhesion when the surfaces to be bonded are warm. The surfaces should be above 45°F to insure an acceptable bond.

OUR CUSTOMERS DON'T JUST *cover their business,*
➔ THEY PROTECT IT



REEF INDUSTRIES, INC.
 9209 Almeda Genoa Rd. • Houston, Texas 77075
 P: 713.507.4251 • F: 713.507.4295
 E-mail: ri@reefindustries.com • www.reefindustries.com

TOLLFREE 1.800.231.6074

The information provided herein is based upon data believed to be reliable. All testing is performed in accordance with ASTM standards and procedures. All values are typical and nominal and do not represent either minimum or maximum performance of the product. Although the information is accurate to the best of our knowledge and belief, no representation of warranty or guarantee is made as to the suitability or completeness of such information. Likewise, no representation of warranty or guarantee, expressed or implied, or merchantability, fitness or otherwise, is made as to product application for a particular use.

TECHNICAL DATA SHEET



DESCRIPTION

Fab Tape™ is a double sided butyl rubber tape. It is available in black.

PHYSICAL PROPERTIES AND TYPICAL VALUES

| PROPERTY | U.S. VALUE | METRIC VALUE |
|-------------------------------|-------------|--------------|
| Thickness | 35 Mills | .9 MM |
| Width | 1.5 In. | 38 MM |
| Roll Length | 100 Ft. | 30.5 M |
| Roll Weight | 3.75 LBS | 1.7 KG |
| Specific Gravity | 1.4 | 1.4 |
| Solubility in Water | Insoluble | Insoluble |
| T-55 Black 3" Peel | 19 LBS | 84.5 N |
| TX-1200 Black 3" Shear | 31 LBS | 138 N |
| Temperature for Testing Above | 50° - 95° F | 10° - 35° C |

INSTALLATION

The surface to be taped should be clean and dry. The tape will not adhere if the surfaces are not properly prepared. Dirty or wet surfaces should be completely cleaned with water, paper towels, dry rags or other materials which will prepare the surface for the tape. Accumulations of dust should also be removed to insure a secure seam.

The product obtains optimum adhesion when the surfaces to be bonded are warm. The surfaces should be above 50-60°F to insure an acceptable bond. In order to obtain a bond at lower temperatures, external heat may be required. The use of an industrial style hot air blower is one recommended method. Extra care should be taken when attempting to install tape at temperatures below 32°F.

OUR CUSTOMERS DON'T JUST *cover their business,*
➔ THEY PROTECT IT



REEF INDUSTRIES, INC.
 9209 Almeda Genoa Rd. • Houston, Texas 77075
 P: 713.507.4251 • F: 713.507.4295
 E-mail: ri@reefindustries.com • www.reefindustries.com

TOLLFREE 1.800.231.6074

The information provided herein is based upon data believed to be reliable. All testing is performed in accordance with ASTM standards and procedures. All values are typical and nominal and do not represent either minimum or maximum performance of the product. Although the information is accurate to the best of our knowledge and belief, no representation of warranty or guarantee is made as to the suitability or completeness of such information. Likewise, no representation of warranty or guarantee, expressed or implied, or merchantability, fitness or otherwise, is made as to product application for a particular use.

TECHNICAL DATA SHEET



DESCRIPTION

Griffolyn® Griff Tape™ FR is a fire retardant pressure sensitive tape. Tape color is white.

PHYSICAL PROPERTIES AND TYPICAL VALUES

| PROPERTY | U.S. VALUE | METRIC VALUE |
|--|------------|--------------|
| Roll Length | 180 Ft | 55 M |
| Roll Weight | 3.75 LBS | 1.7 KG |
| Width | 4 IN | 100 MM |
| Adhesion to Steel | 66 OZ/IN | 72 G/MM |
| Adhesion to Backing | 41 OZ/IN | 45.9 KG/CM |
| Tensile Strength | 26 LBS/IN | 4.5 KG/CM |
| FR Rating: Vertical Burn Time 60 Sec. | 0.5 Sec. | 0.5 Sec. |
| Vertical Burn Drip 60 Sec. | No Drip | No Drip |
| Vertical Burn Length 60 Sec. | 5 IN | 127 MM |

INSTALLATION

The surface to be taped should be clean and dry. The tape will not adhere if the surfaces are not properly prepared. Dirty or wet surfaces should be completely cleaned with water, paper towels, dry rags or other materials which will prepare the surface for the tape. Accumulations of dust should also be removed to insure a secure seam.

The product obtains optimum adhesion when the surfaces to be bonded are warm. The surfaces should be above 50-60°F to insure an acceptable bond. In order to obtain a bond at lower temperatures, external heat may be required. The use of an industrial style hot air blower is one recommended method. Extra care should be taken when attempting to install tape at temperatures below 32°F.

OUR CUSTOMERS DON'T JUST *cover their business,*
➔ THEY PROTECT IT



REEF INDUSTRIES, INC.
 9209 Almeda Genoa Rd. • Houston, Texas 77075
 P: 713.507.4251 • F: 713.507.4295
 E-mail: ri@reefindustries.com • www.reefindustries.com

TOLLFREE 1.800.231.6074

The information provided herein is based upon data believed to be reliable. All testing is performed in accordance with ASTM standards and procedures. All values are typical and nominal and do not represent either minimum or maximum performance of the product. Although the information is accurate to the best of our knowledge and belief, no representation of warranty or guarantee is made as to the suitability or completeness of such information. Likewise, no representation of warranty or guarantee, expressed or implied, or merchantability, fitness or otherwise, is made as to product application for a particular use.

TECHNICAL DATA SHEET



DESCRIPTION

Griffolyn® Ultra VR Tape is a rubber based adhesive tape with a polyethylene film backing. It is moisture and UV resistant. Color: white.

PHYSICAL PROPERTIES AND TYPICAL VALUES

| PROPERTY | U.S. VALUE | METRIC VALUE |
|------------------------------|------------|--------------|
| Roll Length | 180 Ft | 55 M |
| Width | 4 IN | 100 MM |
| Adhesion to Steel | 70 OZ/IN | 7.6 N/CM |
| Elongation | 70 % | 70 % |
| Gauge | 7.5 MILS | .19 MM |
| Tensile 1" | 23 LBS | 102 N |
| Max. Performance Temperature | 180°F | 82°C |

INSTALLATION

The surface to be taped should be clean and dry. The tape will not adhere if the surfaces are not properly prepared. Dirty or wet surfaces should be completely cleaned with water, paper towels, dry rags or other materials which will prepare the surface for the tape. Accumulations of dust should also be removed to insure a secure seam.

The product obtains optimum adhesion when the surfaces to be bonded are warm. The surfaces should be above 50°F to insure an acceptable bond. In order to obtain a bond at lower temperatures, external heat may be required. The use of an industrial style hot air blower is one recommended method. Extra care should be taken when attempting to install tape at temperatures below 32°F.

OUR CUSTOMERS DON'T JUST *cover their business,*
➔ THEY PROTECT IT



REEF INDUSTRIES, INC.
 9209 Almeda Genoa Rd. • Houston, Texas 77075
 P: 713.507.4251 • F: 713.507.4295
 E-mail: ri@reefindustries.com • www.reefindustries.com

TOLLFREE 1.800.231.6074

The information provided herein is based upon data believed to be reliable. All testing is performed in accordance with ASTM standards and procedures. All values are typical and nominal and do not represent either minimum or maximum performance of the product. Although the information is accurate to the best of our knowledge and belief, no representation of warranty or guarantee is made as to the suitability or completeness of such information. Likewise, no representation of warranty or guarantee, expressed or implied, or merchantability, fitness or otherwise, is made as to product application for a particular use.

TECHNICAL DATA SHEET

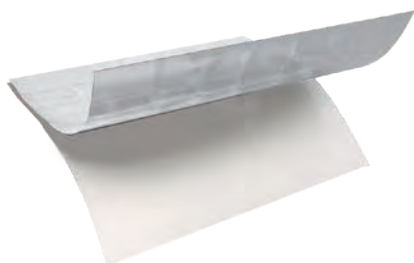

DESCRIPTION

Griffolyn® Sealant Tape is available in white. The adhesive color is white. The rolls are individually shrinkwrapped.

PHYSICAL PROPERTIES AND TYPICAL VALUES

| PROPERTY | U.S. VALUE | METRIC VALUE |
|------------------------------------|-------------|--------------|
| Standard Weight 4" x 50' Roll | 42 Oz | 1.2 Kg |
| Adhesive Thickness | 15 MIL | .38 MM |
| Total Thickness | 22 MIL | .55 MM |
| Peel Strength 1" Width (180° Peel) | 130 oz/in | 14.0 N/mm |
| Shear Strength 3" Width | 18 LBF | 80 N |
| Application Temperature | 30° - 140°F | -1° - 60°C |

INSTALLATION

The surface to be taped should be clean and dry. The tape will not adhere if the surfaces are not properly prepared. Dirty or wet surfaces should be completely cleaned with water, paper towels, dry rags or other materials which will prepare the surface for the tape. Accumulations of dust should also be removed to insure a secure seam.

The product obtains optimum adhesion when the surfaces to be bonded are warm. The surfaces should be above 30°F to insure an acceptable bond. In order to obtain a bond at lower temperatures, external heat may be required. The use of an industrial style hot air blower is one recommended method. Extra care should be taken when attempting to install tape at temperatures below 30°F.

OUR CUSTOMERS DON'T JUST *cover their business,*
➔ THEY PROTECT IT



REEF INDUSTRIES, INC.
 9209 Almeda Genoa Rd. • Houston, Texas 77075
 P: 713.507.4251 • F: 713.507.4295
 E-mail: ri@reefindustries.com • www.reefindustries.com

TOLLFREE 1.800.231.6074

The information provided herein is based upon data believed to be reliable. All testing is performed in accordance with ASTM standards and procedures. All values are typical and nominal and do not represent either minimum or maximum performance of the product. Although the information is accurate to the best of our knowledge and belief, no representation of warranty or guarantee is made as to the suitability or completeness of such information. Likewise, no representation of warranty or guarantee, expressed or implied, or merchantability, fitness or otherwise, is made as to product application for a particular use.

TECHNICAL DATA SHEET

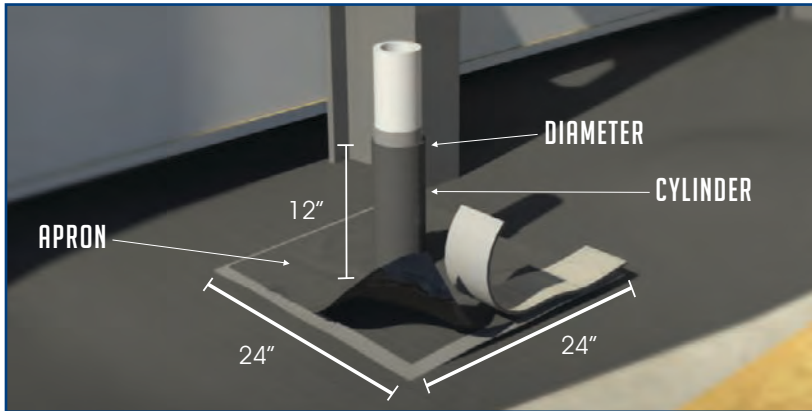

DESCRIPTION

This accessory is typically fabricated with a cylindrical sleeve welded to a flat flange. Standard uses are for placement over pipe penetrations on a vapor retarders. Pipeboots can be fabricated in a variety of diameters or custom made to fit around rectangular columns.

Pipeboot installation requires Fab Tape™

| PART No. | LAYFLAT | DIAMETER | PIPE RANGE | APRON |
|----------|---------|----------|------------------|-----------|
| 60-0075 | 5" | 3" | 1/2" to 2-1/2" | 24" x 24" |
| 60-0076 | 8" | 5" | 2-1/2" to 4-1/2" | 24" x 24" |
| 60-0116 | 14" | 8" | 4-1/2" to 8" | 24" x 24" |



FAB TAPE™

ACCESSORIES

This tape is a double-sided, reinforced black butyl tape for splicing applications. Ideal for applications where a seal is required between overlapping panels of material. Fab Tape™ comes with a release liner.

Rolls are 1.5" wide x 100' in length.

OUR CUSTOMERS DON'T JUST *cover their business,*
➔ THEY PROTECT IT



REEF INDUSTRIES, INC.
 9209 Almeda Genoa Rd. • Houston, Texas 77075
 P: 713.507.4251 • F: 713.507.4295
 E-mail: ri@reefindustries.com • www.reefindustries.com

TOLLFREE 1.800.231.6074

The information provided herein is based upon data believed to be reliable. All testing is performed in accordance with ASTM standards and procedures. All values are typical and nominal and do not represent either minimum or maximum performance of the product. Although the information is accurate to the best of our knowledge and belief, no representation of warranty or guarantee is made as to the suitability or completeness of such information. Likewise, no representation of warranty or guarantee, expressed or implied, or merchantability, fitness or otherwise, is made as to product application for a particular use.

STOCK PIPEBOOTS GRIFFOLYN

3" DIA O.D. PIPE
MAXIMUM



REEF INDUSTRIES PART NO: 60-0075
PIPEBOOTS ARE MADE FROM GRIFFOLYN
MATERIAL. THE 5" LAYFLAT (3" DIA)
PIPEBOOT IS DESIGNED TO FIT PIPES
RANGING FROM $\frac{1}{2}$ " TO $2\frac{1}{2}$ " IN DIAMETER
INCLUDES 24" X 24" APRON

5" DIA O.D. PIPE
MAXIMUM

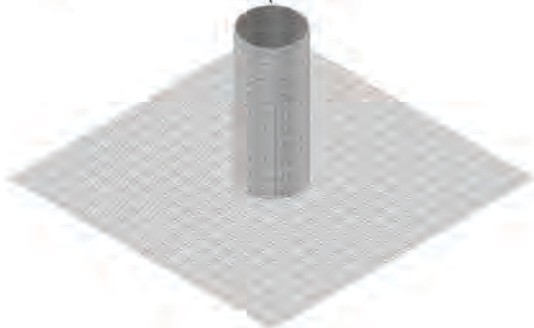

REEF INDUSTRIES PART NO: 60-0076
PIPEBOOTS ARE MADE FROM GRIFFOLYN
MATERIAL. THE 8" LAYFLAT (5" DIA)
PIPEBOOT IS DESIGNED TO FIT PIPES
RANGING FROM $2\frac{1}{2}$ " TO $4\frac{1}{2}$ " IN DIAMETER
INCLUDES 24" X 24" APRON

8" DIA O.D. PIPE
MAXIMUM

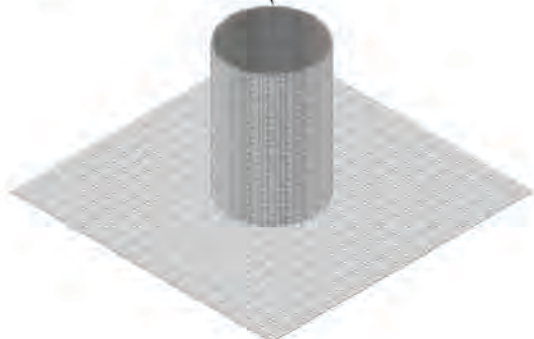

REEF INDUSTRIES PART NO: 60-0116
PIPEBOOTS ARE MADE FROM GRIFFOLYN
MATERIAL. THE 14" LAYFLAT (8" DIA)
PIPEBOOT IS DESIGNED TO FIT PIPES
RANGING FROM $4\frac{1}{2}$ " TO 8" IN DIAMETER
INCLUDES 24" X 24" APRON

NOTE: This document provides information related to the installation of "pipeboots" and its components. This document does not attempt to address all aspects of an installation for all application. The information presented is general information in order to familiarize the individual with the overall scope of the project.

CUSTOM PIPEBOOT INSTALLATION

DWG 1 OF 3

STEP 1
CUT PIPEBOOT OPEN
(HIDDEN LINE REPRESENTS
CUTTING LINE)

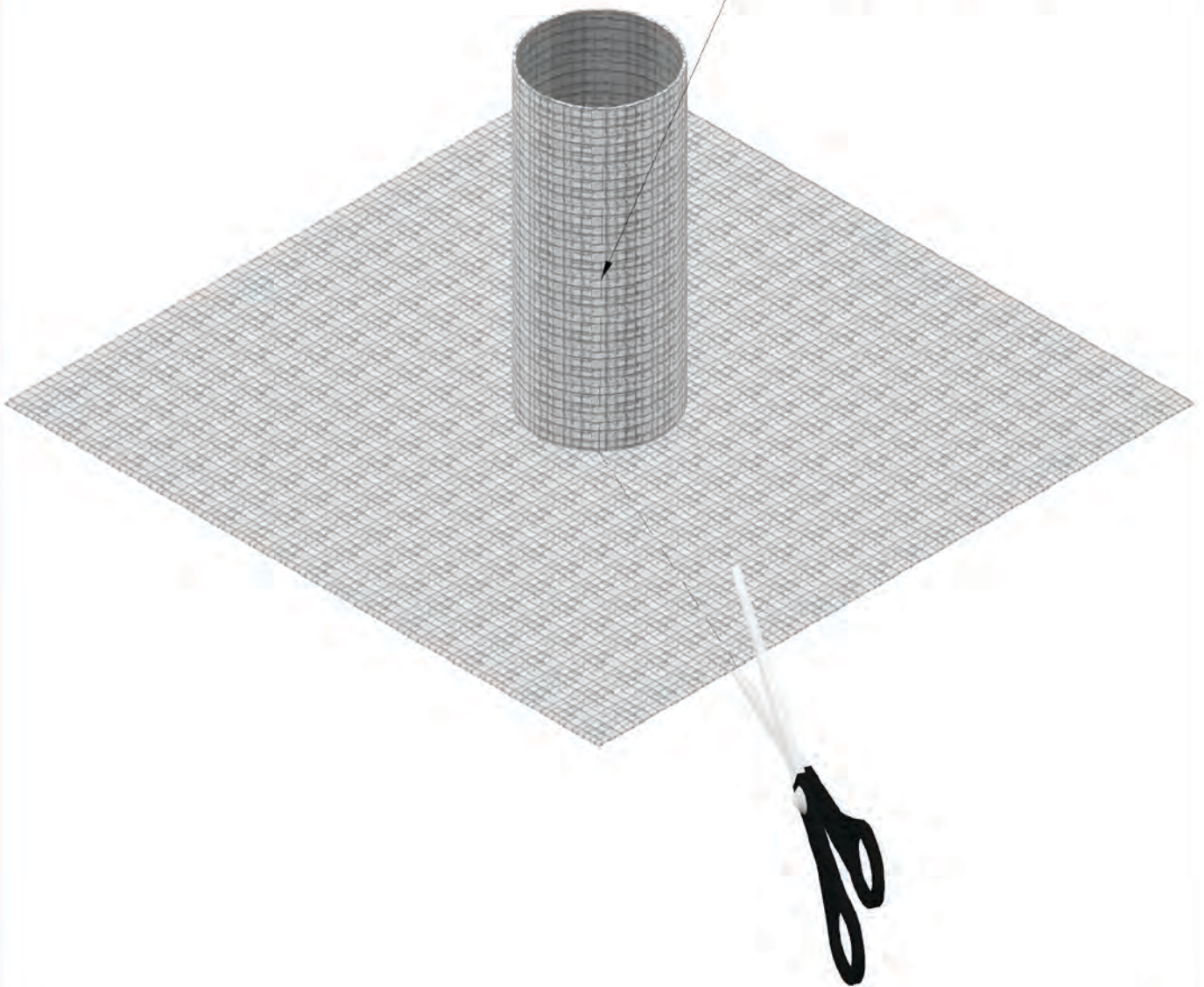

NOTE: This document provides information related to the installation of "pipeboots" and it's components. This document does not attempt to address all aspects of an installation for all application. The information presented is general information in order to familiarize the individual with the overall scope of the project.

CUSTOM PIPEBOOT INSTALLATION

DWG 2 OF 3

STEP 2
APPLY DOUBLE SIDED FAB
TAPE ALONG CUT EDGE
AND AROUND PIPE BELOW
THE TOP EDGE OF PIPEBOOT
(REMOVE RELEASE PAPER
AFTER PIPEBOOT IS
CONFORMED TO PIPE)

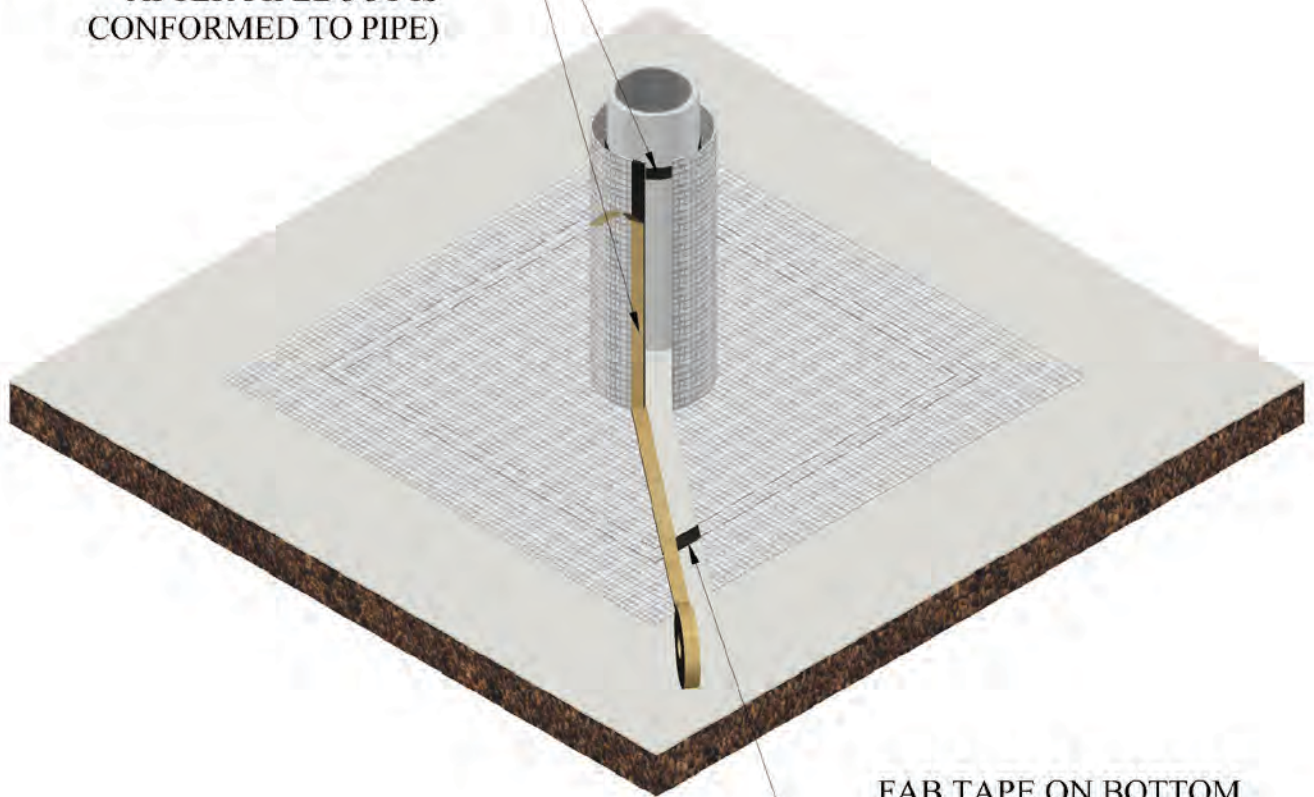

FAB TAPE ON BOTTOM
EDGE BETWEEN VAPOR
RETARDER AND PIPEBOOT
(REMOVE RELEASE PAPER
AFTER PIPEBOOT IS
CONFORMED TO PIPE)

NOTE: This document provides information related to the installation of "pipeboots" and its components. This document does not attempt to address all aspects of an installation for all application. The information presented is general information in order to familiarize the individual with the overall scope of the project.

CUSTOM PIPEBOOT INSTALLATION

DWG 3 OF 3

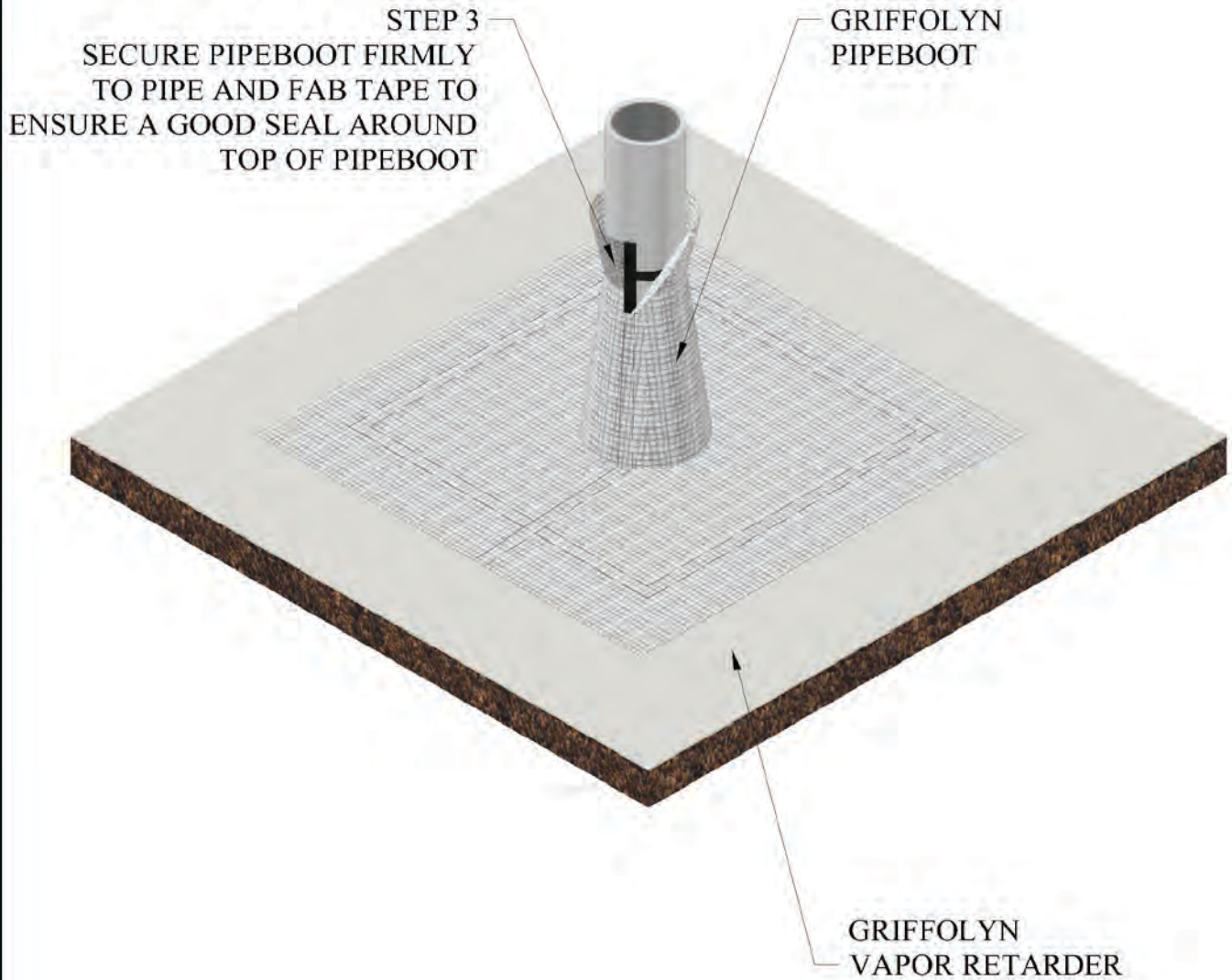

NOTE: This document provides information related to the installation of "pipeboots" and its components. This document does not attempt to address all aspects of an installation for all application. The information presented is general information in order to familiarize the individual with the overall scope of the project.

STANDARD PIPEBOOT INSTALLATION

DWG 1 OF 4

STEP 1
PLACE VAPOR RETARDER OVER
PENETRATION, CUT "X" OPENING
IN THE VAPOR RETARDER

"X" REPRESENTS THE CUT
ON THE VAPOR RETARDER
("X" WILL BE SMALLER
THAN DIAMETER OF PIPE)

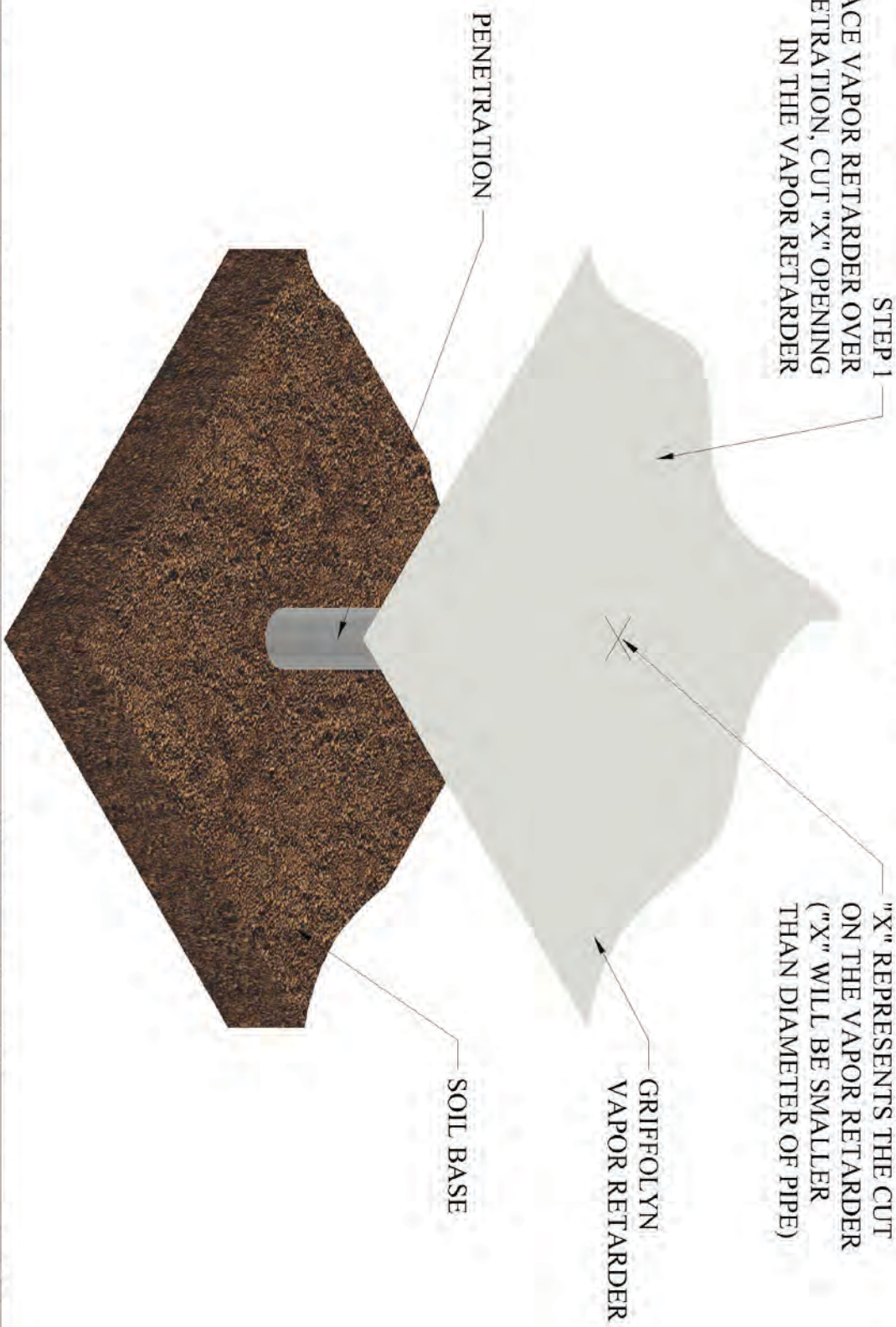

NOTE: This document provides information related to the installation of "pipeboots" and it's components. This document does not attempt to address all aspects of an installation for all application. The information presented is general information in order to familiarize the individual with the overall scope of the project.

STANDARD PIPEBOOT INSTALLATION

DWG 2 OF 4

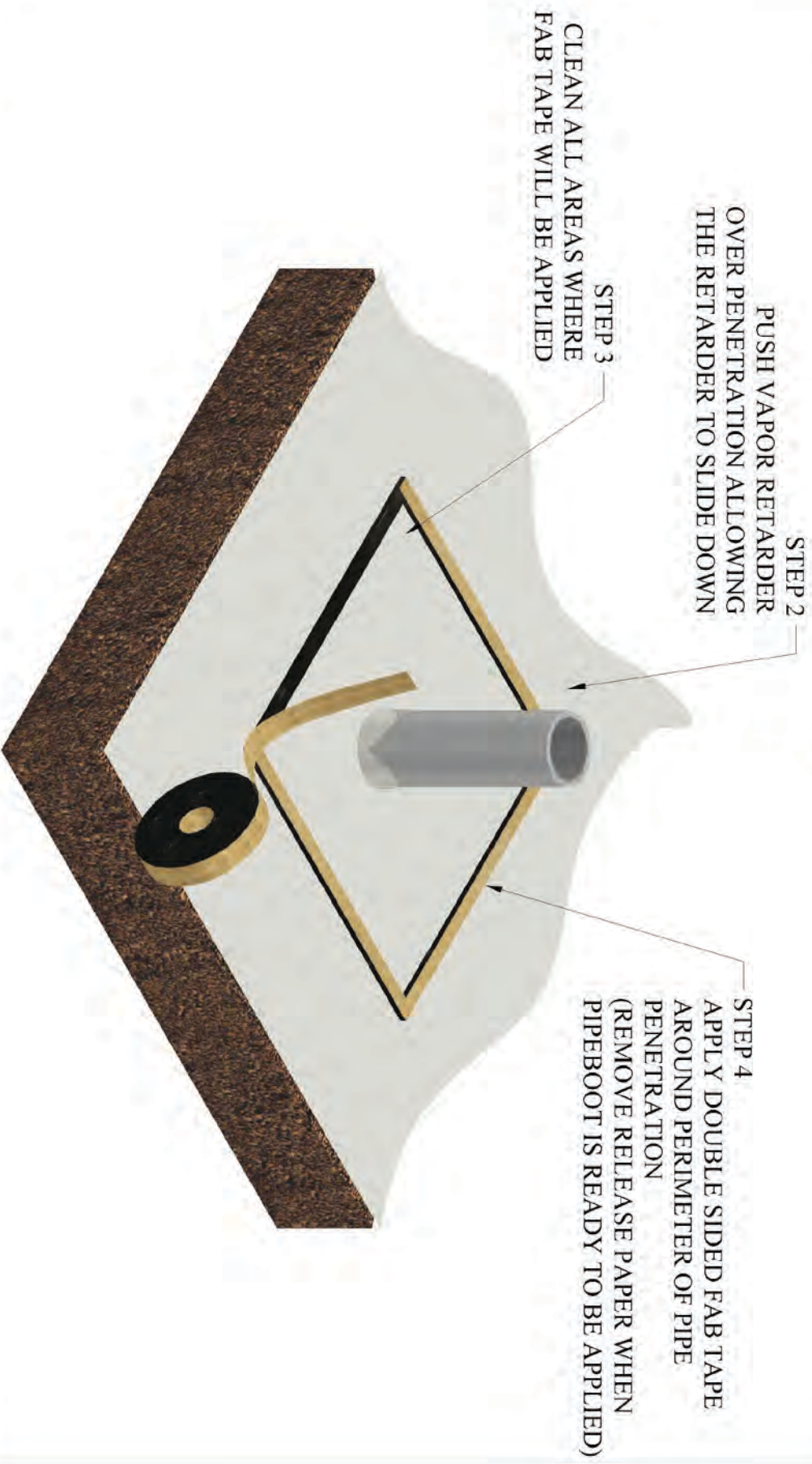

NOTE: This document provides information related to the installation of "pipeboots" and it's components. This document does not attempt to address all aspects of an installation for all application. The information presented is general information in order to familiarize the individual with the overall scope of the project.

STANDARD PIPEBOOT INSTALLATION

DWG 3 OF 4

STEP 5
MARK TOP EDGE WHERE PIPEBOOT
ENDS AND SLIDE PIPEBOOT DOWN
APPROX. 4 INCHES.

STEP 6
APPLY DOUBLE SIDED FAB TAPE
APPROX. 2 INCHES BELOW THE
MARK ON THE PIPE
(REMOVE RELEASE PAPER WHEN
PIPEBOOT IS READY TO BE ATTACHED)

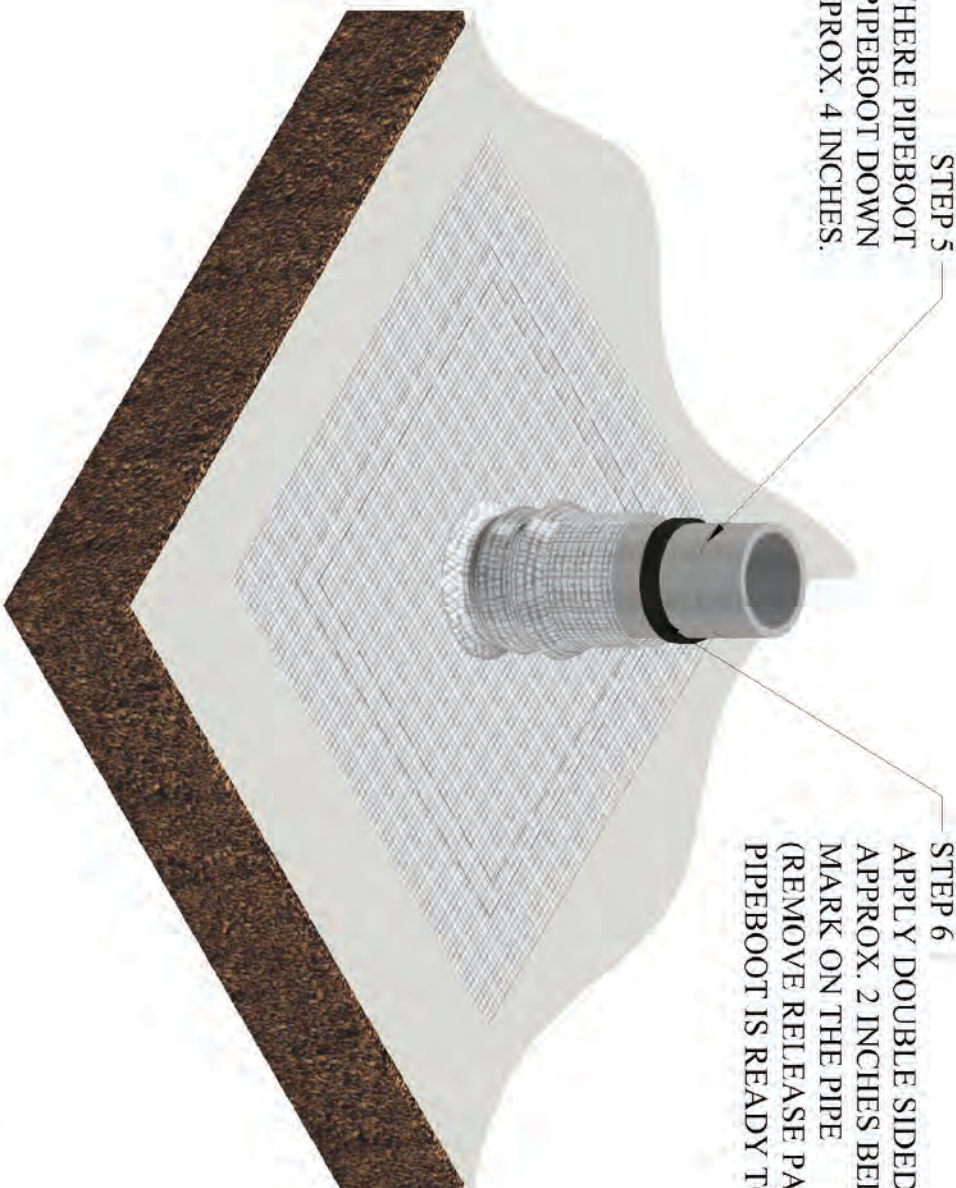

NOTE: This document provides information related to the installation of "pipeboots" and it's components. This document does not attempt to address all aspects of an installation for all application. The information presented is general information in order to familiarize the individual with the overall scope of the project.

STANDARD PIPEBOOT INSTALLATION

DWG 4 OF 4

PLACE PIPEBOOT OVER PENETRATION
AND SECURE PIPEBOOT TO FAB TAPE
ALLOWING PIPEBOOT TO ATTACH TO
THE VAPOR RETARDER

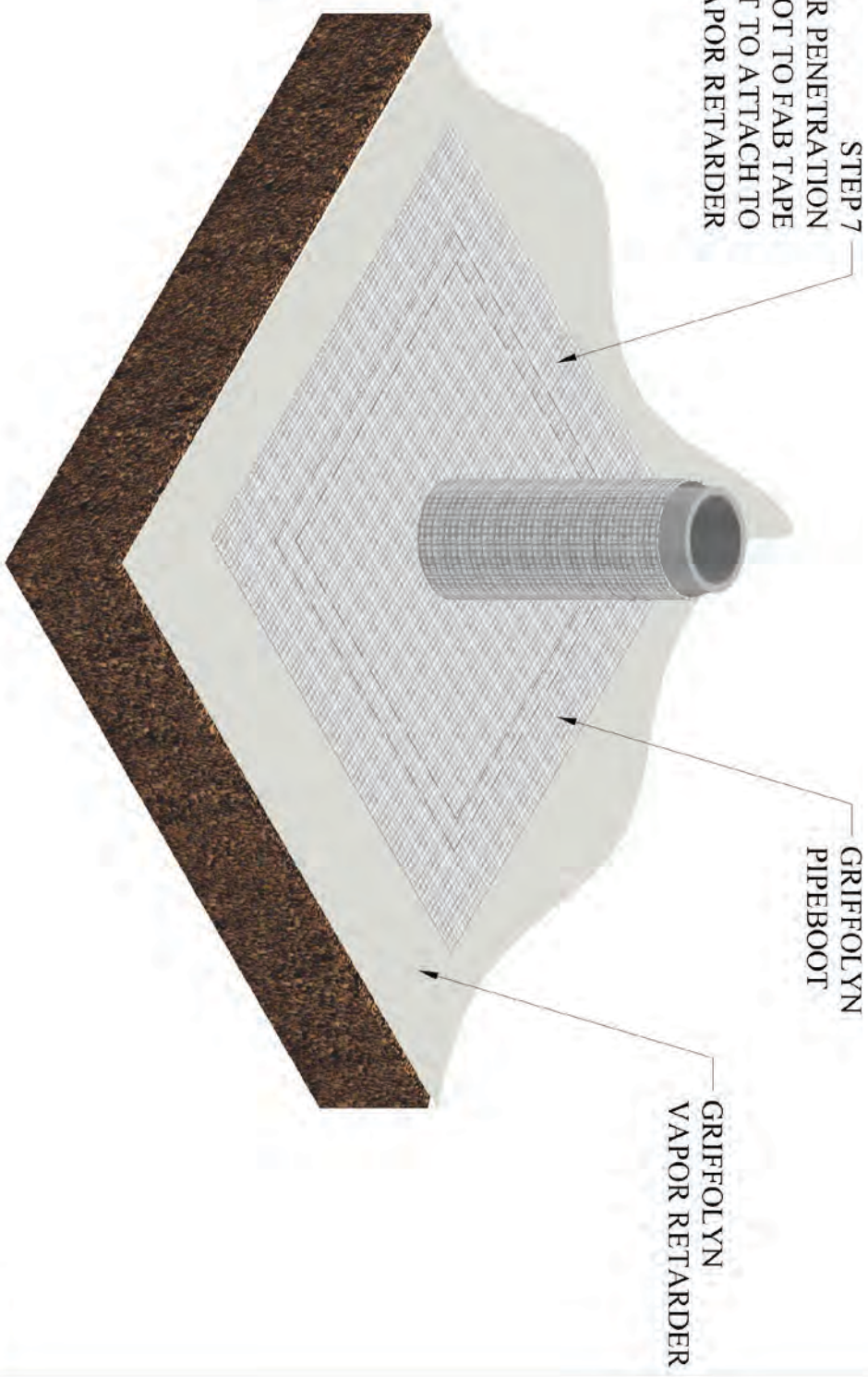

NOTE: This document provides information related to the installation of "pipeboots" and it's components. This document does not attempt to address all aspects of an installation for all application. The information presented is general information in order to familiarize the individual with the overall scope of the project.

Installation Instructions for the Use of Fab Tape™

Fab Tape™ is an asphaltic mastic which creates a durable field seam around penetrations in the material and effectively joins multiple sheets of Griffolyn® Vapor Retarders. Proper installation is imperative to ensure the integrity of the bond.

Both Griffolyn® surfaces must be absolutely clean and dry.

Fab Tape adheres better to sand and dust than to polyethylene. Water creates pockets which can thermally expand and contract sufficiently to degrade adhesion and destroy the seal. When exposed to sunlight, black Griffolyn® can reach temperatures of up to 170°F. Clean thoroughly with mild soap, rinse with clean water and dry completely with a hot air device for best results.

Warm polyethylene surfaces promote better initial adhesion.

It takes about 24 hours in a warm environment for Fab Tape to reach maximum bond strength. When the ambient temperature falls below 60°F the time is extended unless additional heat sources are employed.

Proper grading of the substrate beneath the Griffolyn® Vapor Retarder is essential for optimal sealing.

A rough, rutted and/or lumpy subgrade can cause wrinkles and gaps which will inhibit the bonding process.

To begin installation, lay both sheets over a smooth subgrade with a 6" or more overlap. Apply the Fab Tape 4" back from and parallel to the edge of the bottom sheet. Be sure to smooth out any gaps or voids while applying the tape. If a double seam is required, increase the overlap to 12" and run the second row of tape parallel to and 4" to 6" away from the first row before sealing the first seam.

Remove the release paper to expose the second adhesive side and firmly press the top sheet to the bottom one while maintaining even tension on both sheets. Uneven tension can cause gaps and voids which will prevent proper bonding and cause leaks.

Firm hand pressure is sufficient for initial adhesion on warm sunny days. After 24 hours the bond is permanently set. Overcast conditions and/or temperatures of less than 60°F will require additional heat, pressure and time to bond completely. A veneer proofing roller is very effective for applying additional pressure when the Griffolyn® Vapor Retarder is installed over a smooth subgrade.

Allow adequate time for complete bonding before subjecting the joint to substantial stress.

Call 1-800-231-6074

for answers to your installation questions.

Reef Industries, Inc. 9209 Almeda Genoa Rd. Houston, TX 77075
USA Toll Free 800-231-6074 Tel: 713-507-4251 Fax: 713-507-4295
www.reefindustries.com ri@reefindustries.com

© 2013 REEF INDUSTRIES, INC. Griffolyn is a registered trademark of Reef Industries, Inc

REEF
INDUSTRIES, INC.



GRIFFOLYN®



Call today for technical assistance or to place your order.

9209 Almeda Genoa Rd.
Houston, Texas 77075

P: 713.507.4251
F: 713.507.4295

TOLL FREE
1.800.231.6074

E-mail:
ri@reefindustries.com

www.reefindustries.com
www.griffolyn.com

Reef Industries, Inc.
9209 Almeda Genoa Rd.
Houston, Texas 77075
Toll Free (800) 231-6074
Phone (713) 507-4251
Fax (713) 507-4295
Web Site www.reefindustries.com
E-Mail ri@reefindustries.com

Product Guide Specification

Specifier Notes: This product guide specification is written according to the Construction Specifications Institute (CSI) Format, including *MasterFormat* (1995 Edition), *SectionFormat*, and *PageFormat*, contained in the *CSI Manual of Practice*.

The section must be carefully reviewed and edited by the Architect to meet the requirements of the project and local building code. Coordinate this section with other specification sections and the drawings.

Delete all "Specifier Notes" when editing this section.

SECTION 07260

REINFORCED VAPOR RETARDERS FOR UNDER SLABS

Specifier Notes: This section covers Reef Industries, Inc. "Griffolyn" reinforced vapor retarders for under concrete slab applications.

To prepare a "Short Form" version of this section, delete Articles 1.2 Related Sections, 1.3 References, and 1.5 Quality Assurance. Renumber remaining articles in Part 1.

Consult Reef Industries for assistance in editing this section for the specific application.

PART 1 GENERAL

1.1 SECTION INCLUDES

- A. Reinforced vapor retarders for under concrete slab applications.

1.2 RELATED SECTIONS

Specifier Notes: Edit the following list as required for the project. List other sections with work directly related to the reinforced vapor retarders.

- A. Section 02300 - Earthwork: Subgrade below reinforced vapor retarders.
- B. Section 03300 - Cast-in-Place Concrete.

- C. Section 09620 - Specialty Flooring.
- D. Section 09640 - Wood Flooring.
- E. Section 09650 - Resilient Flooring.
- F. Section 09660 - Static Control Flooring.
- G. Section 09670 - Fluid-Applied Flooring.
- H. Section 09680 - Carpet.

1.3 REFERENCES

Specifier Notes: List standards referenced in this section, complete with designations and titles. This article does not require compliance with standards, but is merely a listing of those used.

- A. ASTM D 882 - Tensile Properties of Thin Plastic Sheeting.
- B. ASTM D 1709 - Impact Resistance of Plastic Film by the Free-Falling Dart Method.
- C. ASTM D 2582 - Puncture-Propagation Tear Resistance of Plastic Film and Thin Sheeting.
- D. ASTM D 3776 - Mass per Unit Area (Weight) of Woven Fabric.
- E. ASTM D 4833 - Index Puncture Resistance of Geotextiles, Geomembranes, and Related Products.
- F. ASTM E 96 - Water Vapor Transmission of Materials.
- G. ASTM E 1643 - Installation of Water Vapor Retarders Used in Contact with Earth or Granular Fill Under Concrete Slabs.
- H. ASTM E 1745 - Water Vapor Retarders Used in Contact with Soil or Granular Fill Under Concrete Slabs.

1.4 SUBMITTALS

- A. Comply with Section 01330 - Submittal Procedures.
- B. Product Data: Submit manufacturer's product data, including installation instructions.
- C. Samples: Submit manufacturer's samples of reinforced vapor retarders.

1.5 QUALITY ASSURANCE

Specifier Notes: Describe requirements for a meeting to coordinate the installation of the reinforced vapor retarders and to sequence related work. Delete this paragraph if not required.

- A. Preinstallation Meeting: Convene a preinstallation meeting [2] [_____] weeks before start of installation of reinforced vapor retarders. Require attendance of parties directly affecting

work of this section, including Contractor, Architect, and installer. Review installation, protection, and coordination with other work.

1.6 DELIVERY, STORAGE, AND HANDLING

- A. Delivery: Deliver materials to site in manufacturer's original, unopened containers and packaging, with labels clearly identifying product name and manufacturer.
- B. Storage: Store materials in a clean, dry area in accordance with manufacturer's instructions.
- C. Handling: Protect materials during handling and installation to prevent damage.

PART 2 PRODUCTS

2.1 MANUFACTURER

- A. Reef Industries, Inc., 9209 Almeda Genoa Rd., Houston, Texas 77075.
Toll Free (800) 231-6074. Phone (713) 507-4251. Fax (713) 507-4295.
Web Site www.reefindustries.com. E-Mail ri@reefindustries.com.

2.2 REINFORCED VAPOR RETARDERS FOR UNDER CONCRETE SLABS

Specifier Notes: Consult Reef Industries for assistance in determining the required reinforced vapor retarder for the specific under slab application. Delete vapor retarders not required.

- A. Reinforced Vapor Retarder: Griffolyn Type-65.
 - 1. Material: 3-ply laminate, combining 2 layers of high-density polyethylene and 1 high-strength non-woven cord grid.
 - 2. Weight, ASTM D 3776: 40 lb/1,000 ft² (19.5 kg/100 m²).
 - 3. Puncture Propagation Tear, ASTM D 2582: 30 lb (133 N).
 - 4. Permeance (Perm), ASTM E 96: 0.038 grains/hr-ft²-in Hg (2.18 ng/(Pa-s-m²)).
 - 5. Drop Dart, ASTM D 1709 Method B: 500 g.
 - 6. Tensile Strength, 3 Inches, ASTM D 882: 100 lb/4,500 psi (445 N/31,470 kPa).
 - 7. Puncture Strength, ASTM D 4833: 33 lb (146 N).
 - 8. Classification, ASTM E 1745: Class C.
 - 9. Usable Temperature Range: -25 to 170 degrees F (-32 to 77 degrees C).

- B. Reinforced Vapor Retarder: Griffolyn Type-85.
 - 1. Material: 5-ply laminate, combining 3 layers of high-density polyethylene and 2 high-strength non-woven cord grids.
 - 2. Weight, ASTM D 3776: 70 lb/1,000 ft² (34.2 kg/100 m²).
 - 3. Puncture Propagation Tear, ASTM D 2582: 55 lb (245 N).
 - 4. Permeance (Perm), ASTM E 96: 0.027 grains/hr-ft²-in Hg (1.551 ng/(Pa-s-m²)).
 - 5. Drop Dart, ASTM D 1709: 2,270 g.
 - 6. Tensile Strength, 3 Inches, ASTM D 882: 240 lb/4100 psi (1070 N/28,200 kPa).
 - 7. Puncture Strength, ASTM D 4833: 50 lb (222 N).
 - 8. Classification, ASTM E 1745: Class A.
 - 9. Usable Temperature Range: -40 to 170 degrees F (-40 to 77 degrees C).

- C. Reinforced Vapor Retarder: Griffolyn Type-105.
 - 1. Material: 7-ply laminate, combining 4 layers of high-density polyethylene and 3 high-

strength non-woven cord grids.

2. Weight, ASTM D 3776: 92 lb/1,000 ft² (44.9 kg/100 m²).
 3. Puncture Propagation Tear, ASTM D 2582: 55 lb (245 N).
 4. Permeance (Perm), ASTM E 96: 0.021 grains/hr-ft²-in Hg (1.207 ng/(Pa-s-m²)).
 5. Drop Dart, ASTM D 1709: 2,300 g.
 6. Tensile Strength, 3 Inches, ASTM D 882: 275 lb/5,464 psi (1,223 N/37,674 kPa).
 7. Puncture Strength, ASTM D 4833: 80 lb (356 N).
 8. Classification, ASTM E 1745: Class A.
 9. Usable Temperature Range: -45 to 170 degrees F (-42 to 77 degrees C).
- D. Reinforced Vapor Retarder: Griffolyn Vaporguard.
1. Material: 3-ply laminate, with an aluminum core surrounded by 2 layers of multi-axially oriented, high-density polyethylene sheets.
 2. Weight, ASTM D 3776: 70 lb/1,000 ft² (34.2 kg/100 m²).
 3. Puncture Propagation Tear, ASTM D 2582: 16 lb (71 N).
 4. Permeance (Perm), ASTM E 96: 0.000 grains/hr-ft²-in Hg (0.000 ng/(Pa-s-m²)).
 5. Drop Dart, ASTM D 1709: 1800 g.
 6. Tensile Strength, 3 Inches, ASTM D 882: 105 lb/2,200 psi (467 N/15,160 kPa).
 7. Puncture Strength, ASTM D 4833: 50 lb (222 N).
 8. Classification, ASTM E 1745: Class C.
 9. Usable Temperature Range: -40 to 170 degrees F (-40 to 77 degrees C).
- E. Reinforced Vapor Retarder: Griffolyn Type-65 G.
1. Material: 4-ply laminate, combining 2 layers of high-density polyethylene and a high-strength non-woven cord grid with a layer of non-woven geotextile fiber.
 2. Weight, ASTM D 3776: 78 lb/1,000 ft² (38 kg/100 m²).
 3. Puncture Propagation Tear, ASTM D 2582: 58 lb (258 N).
 4. Permeance (Perm), ASTM E 96: 0.038 grains/hr-ft²-in Hg (2.18 ng/(Pa-s-m²)).
 5. Drop Dart, ASTM D 1709: 2200 g.
 6. Tensile Strength, 3 Inches, ASTM D 882: 210 lb/1,790psi (930 N/12,370 kPa).
 7. Puncture Strength, ASTM D 4833: 110 lb (489 N).
 8. Classification, ASTM E 1745: Class A.
 9. Usable Temperature Range: -25 to 170 degrees F (-32 to 77 degrees C).

2.3 ACCESSORIES

- A. General: Ensure accessories are from same manufacturer as reinforced vapor retarders.
- B. Mastic Tape: Griffolyn Fab Tape.
1. Description: Black, double-sided, asphaltic, pressure-sensitive, mastic tape.
 2. Weight: 3.75 pounds per 100 feet.
 3. Thickness: 35 mils.
 4. 3 Inch Seam Shear: 35 pounds.
- C. Self-Adhesive Repair Tape: Griffolyn Griff-Tape.
- D. Pipe Boots: Griffolyn pipe boots, factory-fabricated.

PART 3 EXECUTION

3.1 EXAMINATION

- A. Examine areas to receive reinforced vapor retarders. Notify Architect if areas are not acceptable. Do not begin installation until unacceptable conditions have been corrected.

3.2 INSTALLATION

- A. Install reinforced vapor retarders in accordance with ASTM E 1643 and manufacturer's instructions.
- B. Install vapor retarders continuously at locations under slab as indicated on the drawings. Ensure there are no discontinuities in vapor retarder at seams and penetrations.
- C. Install vapor retarders in largest practical widths.
- D. Ensure subgrade beneath vapor retarder is smooth, level, and compacted with no sharp projections.
- E. Join sections of vapor retarder and seal penetrations in vapor retarder with mastic tape. Ensure vapor retarder surfaces to receive mastic tape are clean and dry.
- F. Ensure there is no moisture entrapment by vapor retarder due to rainfall or ground water intrusion.
- G. Immediately repair holes in vapor retarder with self-adhesive repair tape.
- H. Seal around pipes and other penetrations in vapor retarder with pipe boots in accordance with manufacturer's instructions.

3.3 PROTECTION

- A. Protect reinforced vapor retarders from damage during installation of reinforcing steel and utilities and during placement of concrete slab or granular materials.
- B. Immediately repair damaged vapor retarder in accordance with manufacturer's instructions.

END OF SECTION

Reef Industries, Inc.
9209 Almeda Genoa Rd
Houston, Texas 77075
Toll Free (800) 231-6074
Phone (713) 507-4251
Fax (713) 507-4295
Web Site www.reefindustries.com
E-Mail ri@reefindustries.com

Product Guide Specification

Specifier Notes: This product guide specification is written according to the Construction Specifications Institute (CSI) Format, including *MasterFormat* (1995 Edition), *SectionFormat*, and *PageFormat*, contained in the *CSI Manual of Practice*.

The section must be carefully reviewed and edited by the Architect to meet the requirements of the project and local building code. Coordinate this section with other specification sections and the drawings.

Delete all "Specifier Notes" when editing this section.

SECTION 07260

REINFORCED VAPOR RETARDERS FOR ROOF DECKS

Specifier Notes: This section covers Reef Industries, Inc. "Griffolyn" reinforced vapor retarders for roof deck applications.

To prepare a "Short Form" version of this section, delete Articles 1.2 Related Sections, 1.3 References, and 1.5 Quality Assurance. Renumber remaining articles in Part 1.

Consult Reef Industries for assistance in editing this section for the specific application.

PART 1 GENERAL

1.1 SECTION INCLUDES

- A. Reinforced vapor retarders for roof deck applications.

1.2 RELATED SECTIONS

Specifier Notes: Edit the following list as required for the project. List other sections with work directly related to the reinforced vapor retarders.

- A. Section 07220 - Roof and Deck Insulation.
- B. Section 07410 - Metal Roof and Wall Panels.

- C. Section 07420 - Plastic Roof and Wall Panels.
- D. Section 07500 - Membrane Roofing.
- E. Section 07610 - Sheet Metal Roofing.

1.3 REFERENCES

Specifier Notes: List standards referenced in this section, complete with designations and titles. This article does not require compliance with standards, but is merely a listing of those used.

- A. ASTM D 882 - Tensile Properties of Thin Plastic Sheeting.
- B. ASTM D 1709 - Impact Resistance of Plastic Film by the Free-Falling Dart Method.
- C. ASTM D 2582 - Puncture-Propagation Tear Resistance of Plastic Film and Thin Sheeting.
- D. ASTM D 3776 - Mass per Unit Area (Weight) of Woven Fabric.
- E. ASTM D 4833 - Index Puncture Resistance of Geotextiles, Geomembranes, and Related Products.
- F. ASTM E 84 - Surface Burning Characteristics of Building Materials.
- G. ASTM E 96 - Water Vapor Transmission of Materials.
- H. NFPA 701 - Fire Tests for Flame-Resistant Textiles and Films.

1.4 SUBMITTALS

- A. Comply with Section 01330 - Submittal Procedures.
- B. Product Data: Submit manufacturer's product data, including installation instructions.
- C. Samples: Submit manufacturer's samples of reinforced vapor retarders.

1.5 QUALITY ASSURANCE

Specifier Notes: Describe requirements for a meeting to coordinate the installation of the reinforced vapor retarders and to sequence related work. Delete this paragraph if not required.

- A. Preinstallation Meeting: Convene a preinstallation meeting [2] [_____] weeks before start of installation of reinforced vapor retarders. Require attendance of parties directly affecting work of this section, including Contractor, Architect, and installer. Review installation, protection, and coordination with other work.

1.6 DELIVERY, STORAGE, AND HANDLING

- A. Delivery: Deliver materials to site in manufacturer's original, unopened containers and packaging, with labels clearly identifying product name and manufacturer.
- B. Storage: Store materials in a clean, dry area in accordance with manufacturer's instructions.

- C. Handling: Protect materials during handling and installation to prevent damage.

PART 2 PRODUCTS

2.1 MANUFACTURER

- A. Reef Industries, Inc., 9209 Almeda Genoa Rd., Houston, Texas 77075.
Toll Free (800) 231-6074. Phone (713) 507-4251. Fax (713) 507-4295.
Web Site www.reefindustries.com. E-Mail ri@reefindustries.com.

2.2 REINFORCED VAPOR RETARDERS FOR ROOF DECKS

Specifier Notes: Consult Reef Industries for assistance in determining the required reinforced vapor retarder for the specific roof deck application. Delete vapor retarders not required.

- A. Reinforced Vapor Retarder: Griffolyn Type-65.
1. Material: 3-ply laminate, combining 2 layers of high-density polyethylene and 1 high-strength non-woven cord grid.
 2. Weight, ASTM D 3776: 40 lb/1,000 ft² (19.5 kg/100 m²).
 3. Puncture Propagation Tear, ASTM D 2582: 30 lb (133 N).
 4. Permeance (Perm), ASTM E 96: 0.038 grains/hr-ft²-in Hg (2.18 ng/(Pa-s-m²)).
 5. Drop Dart, ASTM D 1709: 500 g.
 6. Tensile Strength, 3 Inches, ASTM D 882: 100 lb/4,500 psi (445 N/31,470 kPa).
 7. Puncture Strength, ASTM D 4833: 33 lb (146 N).
 8. Usable Temperature Range: -25 to 170 degrees F (-32 to 77 degrees C).
- B. Reinforced Vapor Retarder: Griffolyn Type-85.
1. Material: 5-ply laminate, combining 3 layers of high-density polyethylene and 2 high-strength non-woven cord grids.
 2. Weight, ASTM D 3776: 70 lb/1,000 ft² (34.2 kg/100 m²).
 3. Puncture Propagation Tear, ASTM D 2582: 55 lb (245 N).
 4. Permeance (Perm), ASTM E 96: 0.027 grains/hr-ft²-in Hg (1.551 ng/(Pa-s-m²)).
 5. Drop Dart, ASTM D 1709: 2270 g.
 6. Tensile Strength, 3 Inches, ASTM D 882: 240 lb/4,100 psi (1070 N/28,200 kPa).
 7. Puncture Strength, ASTM D 4833: 50 lb (222 N).
 8. Usable Temperature Range: -40 to 170 degrees F (-40 to 77 degrees C).
- C. Reinforced Vapor Retarder: Griffolyn Type-105.
1. Material: 7-ply laminate, combining 4 layers of high-density polyethylene and 3 high-strength non-woven cord grids.
 2. Weight, ASTM D 3776: 92 lb/1,000 ft² (44.9 kg/100 m²).
 3. Puncture Propagation Tear, ASTM D 2582: 55 lb (245 N).
 4. Permeance (Perm), ASTM E 96: 0.021 grains/hr-ft²-in Hg (1.207 ng/(Pa-s-m²)).
 5. Drop Dart, ASTM D 1709: 2,300 g.
 6. Tensile Strength, 3 Inches, ASTM D 882: 275 lb/5,464 psi (1,223 N/37,674 kPa).
 7. Puncture Strength, ASTM D 4833: 80 lb (356 N).
 8. Usable Temperature Range: -45 to 170 degrees F (-42 to 77 degrees C).
- D. Reinforced Vapor Retarder: Griffolyn Vaporguard.
1. Material: 3-ply laminate, with an aluminum core surrounded by 2 layers of multi-axially oriented, high-density polyethylene.

2. Weight, ASTM D 3776: 70 lb/1,000 ft² (34.2 kg/100 m²).
 3. Puncture Propagation Tear, ASTM D 2582: 16 lb (71 N).
 4. Permeance (Perm), ASTM E 96: 0.000 grains/hr-ft²-in Hg (0.000 ng/(Pa-s-m²)).
 5. Drop Dart, ASTM D 1709: 1800 g.
 6. Tensile Strength, 3 Inches, ASTM D 882: 105 lb/2,200 psi (467 N/15,160 kPa).
 7. Puncture Strength, ASTM D 4833: 50 lb (222 N).
 8. Usable Temperature Range: -40 to 170 degrees F (-40 to 77 degrees C).
- E. Fire Retardant Reinforced Vapor Retarder: Griffolyn Type-55 FR.
1. Material: Fire retardant 3-ply laminate, combining 2 layers of linear low-density polyethylene and 1 high-strength non-woven cord grid.
 2. Weight, ASTM D 3776: 30 lb/1,000 ft² (14.6 kg/100 m²).
 3. Puncture Propagation Tear, ASTM D 2582: 21 lb (93 N).
 4. Permeance (Perm), ASTM E 96: 0.062 grains/hr-ft²-in Hg (3.556 ng/(Pa-s-m²)).
 5. Drop Dart, ASTM D 1709: 330 g.
 6. Tensile Strength, 3 Inches, ASTM D 882: 85 lb/5,059 psi (378 N/34,885 kPa).
 7. Puncture Strength, ASTM D 4833: 23 lb (102 N).
 8. Surface Burning Characteristics:
 - a. NFPA 701, Large Scale: Pass.
 - b. UBC 42 and ASTM E 84: Class I, Class A flame spread rating. Flame spread 5, smoke developed 45.
 9. Usable Temperature Range: -5 to 150 degrees F (-20 to 66 degrees C).
- F. Fire Retardant Reinforced Vapor Retarder: Griffolyn TX-1200 FR.
1. Material: Fire retardant 3-ply laminate, combining 2 layers of linear low-density polyethylene and 1 high-strength non-woven cord grid.
 2. Weight, ASTM D 3776: 45 lb/1,000 ft² (22 kg/100 m²).
 3. Puncture Propagation Tear, ASTM D 2582: 33 lb (147 N).
 4. Permeance (Perm), ASTM E 96: 0.036 grains/hr-ft²-in Hg (2.06 ng/(Pa-s-m²)).
 5. Drop Dart, ASTM D 1709 Method B: 730 g.
 6. Tensile Strength, 3 Inches, ASTM D 882: 135 lb/5,500 psi (600 N/38,300 kPa).
 7. Puncture Strength, ASTM D 4833: 26 lb (116 N).
 8. Surface Burning Characteristics:
 - a. NFPA 701, Large Scale: Pass.
 - b. UBC 42 and ASTM E 84: Class I, Class A flame spread rating. Flame spread 5, smoke developed 70.
 9. Usable Temperature Range: -10 to 170 degrees F (-23 to 77 degrees C).
- G. Fire Retardant Reinforced Vapor Retarder: Griffolyn Type-90 FR.
1. Material: 5-ply laminate, combining 3 layers of linear low-density polyethylene and 2 high-strength non-woven cord grids.
 2. Weight, ASTM D 3776: 85 lb/1,000 ft² (41.5 kg/100 m²).
 3. Puncture Propagation Tear, ASTM D 2582: 47 lb (209 N).
 4. Permeance (Perm), ASTM E 96: 0.028 grains/hr-ft²-in Hg (1.61 ng/(Pa-s-m²)).
 5. Drop Dart, ASTM D 1709 Method B: 1,200 g.
 6. Tensile Strength, 3 Inches, ASTM D 882: 170 lb/3,650 psi (750 N/25,200 kPa).
 7. Puncture Strength, ASTM D 4833: 47 lb (209 N).
 9. Surface Burning Characteristics:
 - a. NFPA 701, Large Scale: Pass.
 - b. UBC 42 and ASTM E 84: Class I, Class B flame spread rating. Flame spread 5, smoke developed 135.
- Usable Temperature Range: -40 to 170 degrees F (-40 to 77 degrees C).

2.3 ACCESSORIES

- A. General: Ensure accessories are from same manufacturer as reinforced vapor retarders.
- B. Mastic Tape: Griffolyn Fab Tape.
 - 1. Description: Black, double-sided, asphaltic, pressure-sensitive, mastic tape.
 - 2. Weight: 3.75 pounds per 100 feet.
 - 3. Thickness: 35 mils.
 - 4. 3 Inch Seam Shear: 35 pounds.
- C. Self-Adhesive Repair Tape: Griffolyn Griff-Tape.
- D. Pipe Boots: Griffolyn pipe boots, factory-fabricated.

PART 3 EXECUTION

3.1 EXAMINATION

- A. Examine areas to receive reinforced vapor retarders. Notify Architect if areas are not acceptable. Do not begin installation until unacceptable conditions have been corrected.

3.2 INSTALLATION

- A. Install reinforced vapor retarders in accordance with manufacturer's instructions.
- B. Install vapor retarders continuously at locations on roof deck as indicated on the drawings. Ensure there are no discontinuities in vapor retarder at seams and penetrations.
- C. Install vapor retarders in largest practical widths.
- D. Ensure surface beneath vapor retarder is smooth with no sharp projections.
- E. Join sections of vapor retarder and seal penetrations in vapor retarder with mastic tape. Ensure vapor retarder surfaces to receive mastic tape are clean and dry.
- F. Immediately repair holes in vapor retarder with self-adhesive repair tape.
- G. Seal around pipes and other penetrations in vapor retarder with pipe boots in accordance with manufacturer's instructions.

3.3 PROTECTION

- A. Protect reinforced vapor retarders from damage until covered by roof insulation.
- B. Immediately repair damaged vapor retarder in accordance with manufacturer's instructions.

END OF SECTION

Reef Industries, Inc.
9209 Almeda Genoa Rd.
Houston, Texas 77075
Toll Free (800) 231-6074
Phone (713) 507-4251
Fax (713) 507-4295
Web Site www.reefindustries.com
E-Mail ri@reefindustries.com

Product Guide Specification

Specifier Notes: This product guide specification is written according to the Construction Specifications Institute (CSI) Format, including *MasterFormat* (1995 Edition), *SectionFormat*, and *PageFormat*, contained in the *CSI Manual of Practice*.

The section must be carefully reviewed and edited by the Architect to meet the requirements of the project and local building code. Coordinate this section with other specification sections and the drawings.

Delete all "Specifier Notes" when editing this section.

SECTION 07260

REINFORCED VAPOR RETARDERS FOR WALLS

Specifier Notes: This section covers Reef Industries, Inc. "Griffolyn" reinforced vapor retarders for wall applications.

To prepare a "Short Form" version of this section, delete Articles 1.2 Related Sections, 1.3 References, and 1.5 Quality Assurance. Renumber remaining articles in Part 1.

Consult Reef Industries for assistance in editing this section for the specific application.

PART 1 GENERAL

1.1 SECTION INCLUDES

- A. Reinforced vapor retarders for wall applications.

1.2 RELATED SECTIONS

Specifier Notes: Edit the following list as required for the project. List other sections with work directly related to the reinforced vapor retarders.

- A. Section 07410 - Metal Roof and Wall Panels.
- B. Section 07420 - Plastic Roof and Wall Panels.

- C. Section 07460 - Siding.
- D. Section 09250 - Gypsum Board.
- E. Section 09500 - Ceilings.
- F. Section 09720 - Wall Covering.

1.3 REFERENCES

Specifier Notes: List standards referenced in this section, complete with designations and titles. This article does not require compliance with standards, but is merely a listing of those used.

- A. ASTM D 882 - Tensile Properties of Thin Plastic Sheeting.
- B. ASTM D 1709 - Impact Resistance of Plastic Film by the Free-Falling Dart Method.
- C. ASTM D 2582 - Puncture-Propagation Tear Resistance of Plastic Film and Thin Sheeting.
- D. ASTM D 3776 - Mass per Unit Area (Weight) of Woven Fabric.
- E. ASTM D 4833 - Index Puncture Resistance of Geotextiles, Geomembranes, and Related Products.
- F. ASTM E 84 - Surface Burning Characteristics of Building Materials.
- G. ASTM E 96 - Water Vapor Transmission of Materials.
- H. NFPA 701 - Fire Tests for Flame-Resistant Textiles and Films.

1.4 SUBMITTALS

- A. Comply with Section 01330 - Submittal Procedures.
- B. Product Data: Submit manufacturer's product data, including installation instructions.
- C. Samples: Submit manufacturer's samples of reinforced vapor retarders.

1.5 QUALITY ASSURANCE

Specifier Notes: Describe requirements for a meeting to coordinate the installation of the reinforced vapor retarders and to sequence related work. Delete this paragraph if not required.

- A. Preinstallation Meeting: Convene a preinstallation meeting [2] [_____] weeks before start of installation of reinforced vapor retarders. Require attendance of parties directly affecting work of this section, including Contractor, Architect, and installer. Review installation, protection, and coordination with other work.

1.6 DELIVERY, STORAGE, AND HANDLING

- A. Delivery: Deliver materials to site in manufacturer's original, unopened containers and

packaging, with labels clearly identifying product name and manufacturer.

- B. Storage: Store materials in a clean, dry area in accordance with manufacturer's instructions.
- C. Handling: Protect materials during handling and installation to prevent damage.

PART 2 PRODUCTS

2.1 MANUFACTURER

- A. Reef Industries, Inc., 9209 Almeda Genoa Rd., Houston, Texas 77075.
Toll Free (800) 231-6074. Phone (713) 507-4251. Fax (713) 507-4295.
Web Site www.reefindustries.com. E-Mail ri@reefindustries.com.

2.2 REINFORCED VAPOR RETARDERS FOR WALLS

Specifier Notes: Consult Reef Industries for assistance in determining the required reinforced vapor retarder for the specific wall application. Delete vapor retarders not required.

- A. Reinforced Vapor Retarder: Griffolyn Type-65.
 - 1. Material: 3-ply laminate, combining 2 layers of high-density polyethylene and 1 high-strength non-woven cord grid.
 - 2. Weight, ASTM D 3776: 40 lb/1,000 ft² (19.5 kg/100 m²).
 - 3. Puncture Propagation Tear, ASTM D 2582: 30 lb (133 N).
 - 4. Permeance (Perm), ASTM E 96: 0.038 grains/hr-ft²-in Hg (2.18 ng/(Pa-s-m²)).
 - 5. Drop Dart, ASTM D 1709: 500 g.
 - 6. Tensile Strength, 3 Inches, ASTM D 882: 100 lb/4,500 psi (445 N/31,470 kPa).
 - 7. Puncture Strength, ASTM D 4833: 33 lb (146 N).
 - 8. Usable Temperature Range: -25 to 170 degrees F (-32 to 77 degrees C).
- B. Reinforced Vapor Retarder: Griffolyn Type-85.
 - 1. Material: 5-ply laminate, combining 3 layers of high-density polyethylene and 2 high-strength non-woven cord grids.
 - 2. Weight, ASTM D 3776: 70 lb/1,000 ft² (34.2 kg/100 m²).
 - 3. Puncture Propagation Tear, ASTM D 2582: 55 lb (245 N).
 - 4. Permeance (Perm), ASTM E 96: 0.027 grains/hr-ft²-in Hg (1.551 ng/(Pa-s-m²)).
 - 5. Drop Dart, ASTM D 1709: 2270 g.
 - 6. Tensile Strength, 3 Inches, ASTM D 882: 240 lb/4,100 psi (1070 N/28,200 kPa).
 - 7. Puncture Strength, ASTM D 4833: 50 lb (222 N).
 - 8. Usable Temperature Range: -40 to 170 degrees F (-40 to 77 degrees C).
- C. Reinforced Vapor Retarder: Griffolyn Type-105.
 - 1. Material: 7-ply laminate, combining 4 layers of high-density polyethylene and 3 high-strength non-woven cord grids.
 - 2. Weight, ASTM D 3776: 92lb/1,000 ft² (44.9 kg/100 m²).
 - 3. Puncture Propagation Tear, ASTM D 2582: 55 lb (245 N).
 - 4. Permeance (Perm), ASTM E 96: 0.021 grains/hr-ft²-in Hg (1.207 ng/(Pa-s-m²)).
 - 5. Drop Dart, ASTM D 1709: 2,300 g.
 - 6. Tensile Strength, 3 Inches, ASTM D 882: 275 lb/5,464 psi (1,223 N/37,674 kPa).
 - 7. Puncture Strength, ASTM D 4833: 80 lb (356 N).
 - 8. Usable Temperature Range: -45 to 170 degrees F (-42 to 77 degrees C).

- D. Reinforced Vapor Retarder: Griffolyn Vaporguard.
1. Material: 3-ply laminate, with an aluminum core surrounded by 2 layers of multi-axially oriented, high-density polyethylene.
 2. Weight, ASTM D 3776: 70 lb/1,000 ft² (34.2 kg/100 m²).
 3. Puncture Propagation Tear, ASTM D 2582: 16 lb (71 N).
 4. Permeance (Perm), ASTM E 96: 0.000 grains/hr-ft²-in Hg (0.000 ng/(Pa-s-m²)).
 5. Drop Dart, ASTM D 1709: 1800 g.
 6. Tensile Strength, 3 Inches, ASTM D 882: 105 lb/2,200 psi (467 N/15,160 kPa).
 7. Puncture Strength, ASTM D 4833: 50 lb (222 N).
 8. Usable Temperature Range: -40 to 170 degrees F (-40 to 77 degrees C).
- E. Fire Retardant Reinforced Vapor Retarder: Griffolyn Type-55 FR.
1. Material: Fire retardant 3-ply laminate, combining 2 layers of linear low-density polyethylene and 1 high-strength non-woven cord grid.
 2. Weight, ASTM D 3776: 32 lb/1,000 ft² (14.6 kg/100 m²).
 3. Puncture Propagation Tear, ASTM D 2582: 21 lb (93 N).
 4. Permeance (Perm), ASTM E 96: 0.062 grains/hr-ft²-in Hg (3.556 ng/(Pa-s-m²)).
 5. Drop Dart, ASTM D 1709: 330 g.
 6. Tensile Strength, 3 Inches, ASTM D 882: 85 lb/5,059 psi (378 N/34,885 kPa).
 7. Puncture Strength, ASTM D 4833: 23 lb (102 N).
 8. Surface Burning Characteristics:
 - a. NFPA 701, Large Scale: Pass.
 - b. UBC 42 and ASTM E 84: Class I, Class A flame spread rating. Flame spread 5, smoke developed 45.
 9. Usable Temperature Range: -5 to 150 degrees F (-20 to 66 degrees C).
- F. Fire Retardant Reinforced Vapor Retarder: Griffolyn TX-1200 FR.
1. Material: Fire retardant 3-ply laminate, combining 2 layers of linear low-density polyethylene and 1 high-strength non-woven cord grid.
 2. Weight, ASTM D 3776: 45 lb/1,000 ft² (22 kg/100 m²).
 3. Puncture Propagation Tear, ASTM D 2582: 33 lb (147 N).
 4. Permeance (Perm), ASTM E 96: 0.036 grains/hr-ft²-in Hg (2.06 ng/(Pa-s-m²)).
 5. Drop Dart, ASTM D 1709 Method B: 730 g.
 6. Tensile Strength, 3 Inches, ASTM D 882: 135 lb/5,500 psi (600 N/38,300 kPa).
 7. Puncture Strength, ASTM D 4833: 26 lb (116 N).
 8. Surface Burning Characteristics:
 - a. NFPA 701, Large Scale: Pass.
 - b. UBC 42 and ASTM E 84: Class I, Class A flame spread rating. Flame spread 5 smoke developed 70.
 9. Usable Temperature Range: -10 to 170 degrees F (-23 to 77 degrees C).
- G. Fire Retardant Reinforced Vapor Retarder: Griffolyn Type-90 FR.
1. Material: Fire retardant 5-ply laminate, combining 3 layers of linear low-density polyethylene and 2 high-strength non-woven cord grids.
 2. Weight, ASTM D 3776: 85 lb/1,000 ft² (41.5 kg/100 m²).
 3. Puncture Propagation Tear, ASTM D 2582: 47 lb (209 N).
 4. Permeance (Perm), ASTM E 96: 0.028 grains/hr-ft²-in Hg (1.61 ng/(Pa-s-m²)).
 5. Drop Dart, ASTM D 1709: 1,200 g.
 6. Tensile Strength, 3 Inches, ASTM D 882: 170 lb/3,650 psi (750N/25,200 kPa).
 7. Puncture Strength, ASTM D 4833: 47 lb (209 N).
 8. Surface Burning Characteristics:

- a. NFPA 701, Large Scale: Pass.
 - b. UBC 42 and ASTM E 84: Class 1, Class B flame spread rating. Flame spread 5, smoke developed 135.
9. Usable Temperature Range: -40 to 170 degrees F (-40 to 77 degrees C).

2.3 ACCESSORIES

- A. General: Ensure accessories are from same manufacturer as reinforced vapor retarders.
- B. Mastic Tape: Griffolyn Fab Tape.
 1. Description: Black, double-sided, asphaltic, pressure-sensitive, mastic tape.
 2. Weight: 3.75 pounds per 100 feet.
 3. Thickness: 35 mils.
 4. 3 Inch Seam Shear: 35 pounds.
- C. Self-Adhesive Repair Tape: Griffolyn Griff-Tape.
- D. Pipe Boots: Griffolyn pipe boots, factory-fabricated.

PART 3 EXECUTION

3.1 EXAMINATION

- A. Examine areas to receive reinforced vapor retarders. Notify Architect if areas are not acceptable. Do not begin installation until unacceptable conditions have been corrected.

3.2 INSTALLATION

- A. Install reinforced vapor retarders in accordance with manufacturer's instructions.
- B. Install vapor retarders continuously at locations on walls as indicated on the drawings. Ensure there are no discontinuities in vapor retarder at seams and penetrations.
- C. Install vapor retarders in largest practical widths.
- D. Ensure surface behind vapor retarder is smooth with no sharp projections.
- E. Join sections of vapor retarder and seal penetrations in vapor retarder with mastic tape. Ensure vapor retarder surfaces to receive mastic tape are clean and dry.
- F. Immediately repair holes in vapor retarder with self-adhesive repair tape.
- G. Seal around pipes and other penetrations in vapor retarder with pipe boots in accordance with manufacturer's instructions.

3.3 PROTECTION

- A. Protect reinforced vapor retarders from damage until covered by finish wall.
- B. Immediately repair damaged vapor retarder in accordance with manufacturer's instructions.

END OF SECTION

Installation Instructions Griffolyn® Under Slab Vapor Retarders

Note: These installation instructions need to be read completely before beginning any installation of the Griffolyn® System to ensure effective/proper methods of installation are used. The Griffolyn® System includes Griffolyn® vapor retarder material, Fab Tape, (an asphaltic mastic), and pipeboots. (Installation instructions for Griffolyn® Type 65G and R30G are covered in a separate sheet.)

1. Prior to the placement of the reinforcing steel and the pouring of concrete, ensure the subgrade beneath the vapor retarder is smooth, level and compacted. The Griffolyn® vapor retarders can be installed over sand, smooth aggregate or a tamped earth base. If a Griffolyn® vapor retarder is to be placed over coarse granular fill, a thin layer of approximately 1" of fine graded material should be rolled or compacted over the fill prior to installing the vapor retarder.

2. Install Griffolyn® continuously at locations under slab as indicated on the drawings. Ensure there are no discontinuities in the Griffolyn at seams and penetrations. Griffolyn® is rolled out in the widest practical widths (minimum 20' wide) parallel to the direction of the concrete pour, totally covering the future slab site. Allow sufficient material along perimeter walls to cover wall areas up to top of slab elevations.

3. All joints/seams shall be overlapped six inches. To seal the joint/overlapped area, fold the Griffolyn® top section back and apply the Fab Tape 4 inches (100 mm) back and parallel to the edge of the bottom section (See drawing.) Smooth out any folds or wrinkles in the vapor retarder while applying the tape. Remove the release paper starting at one end of the taped section and firmly press the top section to the bottom while maintaining even tension to avoid gaps, which could cause leaks. Allow adequate time for complete bonding before subjecting the seam to substantial stress.

4. Seal around pipes and other penetrations in the vapor retarder using Griffolyn® Pipe Boots. Attach Fab Tape around the bottom perimeter of the pipe boot flange ensuring the ends of the tape overlap slightly. Remove one section of the release paper. Lower the boot over the penetration and press the exposed tape firmly to the vapor retarder material. Remove the remaining release paper and secure the remainder of the flange.

Lower the tube section of the pipe boot and wrap the Fab Tape around the pipe. Place the tape to allow some slack when the boot is raised above the tape. Remove release paper. Raise the tube section and secure over tape. Secure the pipe boot tube in place with clamp or tie down over the Fab Tape. (See pipe boot installation details)

5. Holes and tears that occur during or after installation must be repaired before concrete slab placement. Cut a rectangular Griffolyn® piece 6 -12 inches larger than the area to be repaired. Attach Fab Tape around the perimeter of the patch, ensuring the ends of the Fab Tape overlap. Remove the release paper from the Fab Tape. Firmly press the patch material to the Griffolyn® vapor retarder maintaining even tension to avoid gaps.

6. Lap Griffolyn® vapor retarder up vertical walls to an elevation equal to the top slab surface and on top of footings. Secure vapor retarder to the wall using two rows of Fab Tape (See Drawing.) Important: For all joints/seams, pipe boot installations or repairs both Griffolyn® surfaces should be clean and dry, free of moisture dirt and dust to ensure optimal bonding and sealing. If the air temperature drops below 40 degrees F (4 degrees C) measures must be taken to ensure the seamed area/tape provides an effective seal.

Critical: All ponded water from rainfall, washing operations, etc, should be removed from on top of the vapor retarder prior to placement of the concrete.

Jan-2013



Call today for technical assistance or to place your order.

9209 Alameda Genoa Rd.
Houston, Texas 77075

P: 713.507.4251
F: 713.507.4295

TOLL FREE
1.800.231.6074

E-mail:
ri@reefindustries.com

www.reefindustries.com
www.griffolyn.com

Detail Architectural Drawings

Fab Tape™ Seam (DWG & Instruction Sheet)

Concrete Slab on Grade – Grade Beam Detail Fig 1 (DWG)

Concrete Slab on Grade – Grade Beam Detail Fig 2 (DWG)

Concrete Slab on Grade – Grade Beam Detail Fig 3 (DWG)

Concrete Slab on Grade – Grade Beam Detail Fig 4 (DWG)

Griffolyn® Repair

Griffolyn® Fire Retardant Products Repair

Vapor Retarder Attachment to Stem Wall

Detail Vapor Retarder Fig 1

Detail Vapor Retarder Fig 2

Detail Vapor Retarder Door Detail

Detail Vapor Retarder Window Detail

Griffolyn® Griff Tape™ / FR – General Installation Instructions

Pipe Cluster Griffolyn® Repair 1

Pipe Cluster Griffolyn® Repair 2

Batten Detail Hilti

Batten Detail with Screws

Updated August 2014

REEF
INDUSTRIES, INC.



GRIFFOLYN®



Call today for technical
assistance or to place
your order.

9209 Almeda Genoa Rd.
Houston, Texas 77075

P: 713.507.4251
F: 713.507.4295

TOLL FREE
1.800.231.6074

E-mail:
ri@reefindustries.com

www.reefindustries.com
www.griffolyn.com

Fab Tape™ Seams

Fab Tape™ is an asphaltic mastic which creates a durable field seam between multiple sections and for sealing around penetrations in a vapor retarder. Proper installation is imperative to ensure optimal bonding and sealing.

Both Griffolyn® surfaces must be clean and dry. On a dirty surface, the tape will adhere to the sand and dust instead of the Griffolyn® vapor retarder. If the surface is wet, pockets of moisture are created which can thermally contract and expand sufficiently to degrade adhesion and destroy the seal.

Warm temperatures will promote better initial adhesion. Fab Tape™ will reach maximum bond strength in about 24 hours in a warm environment. Ambient temperatures of less than 60°F will extend the time required for bonding unless additional heat sources are applied.

Proper grading of the substrate beneath the vapor retarder is essential for optimal sealing. A rough, rutted and/or lumpy subgrade can cause wrinkles and gaps in the seam area which make it difficult to achieve an effective bond.

To begin installation, lay both sheets over a smooth subgrade with a 6" overlap. Fold the top section back and apply the Fab Tape™ 4" back and parallel to the edge of the bottom section. Smooth out any gaps or voids while applying the tape.

Remove the release paper and firmly press the top section to the bottom while maintaining even tension on the material to avoid gaps which could cause leaks.

Allow adequate time for complete bonding before subjecting the joint to substantial stress.

Fab Tape™ Seam Instructions

V1.0 August 2014



Call today for technical assistance or to place your order.

9209 Almeda Genoa Rd.
Houston, Texas 77075

P: 713.507.4251
F: 713.507.4295

TOLL FREE
1.800.231.6074

E-mail:
ri@reefindustries.com

www.reefindustries.com
www.griffolyn.com

FAB TAPE SEAM

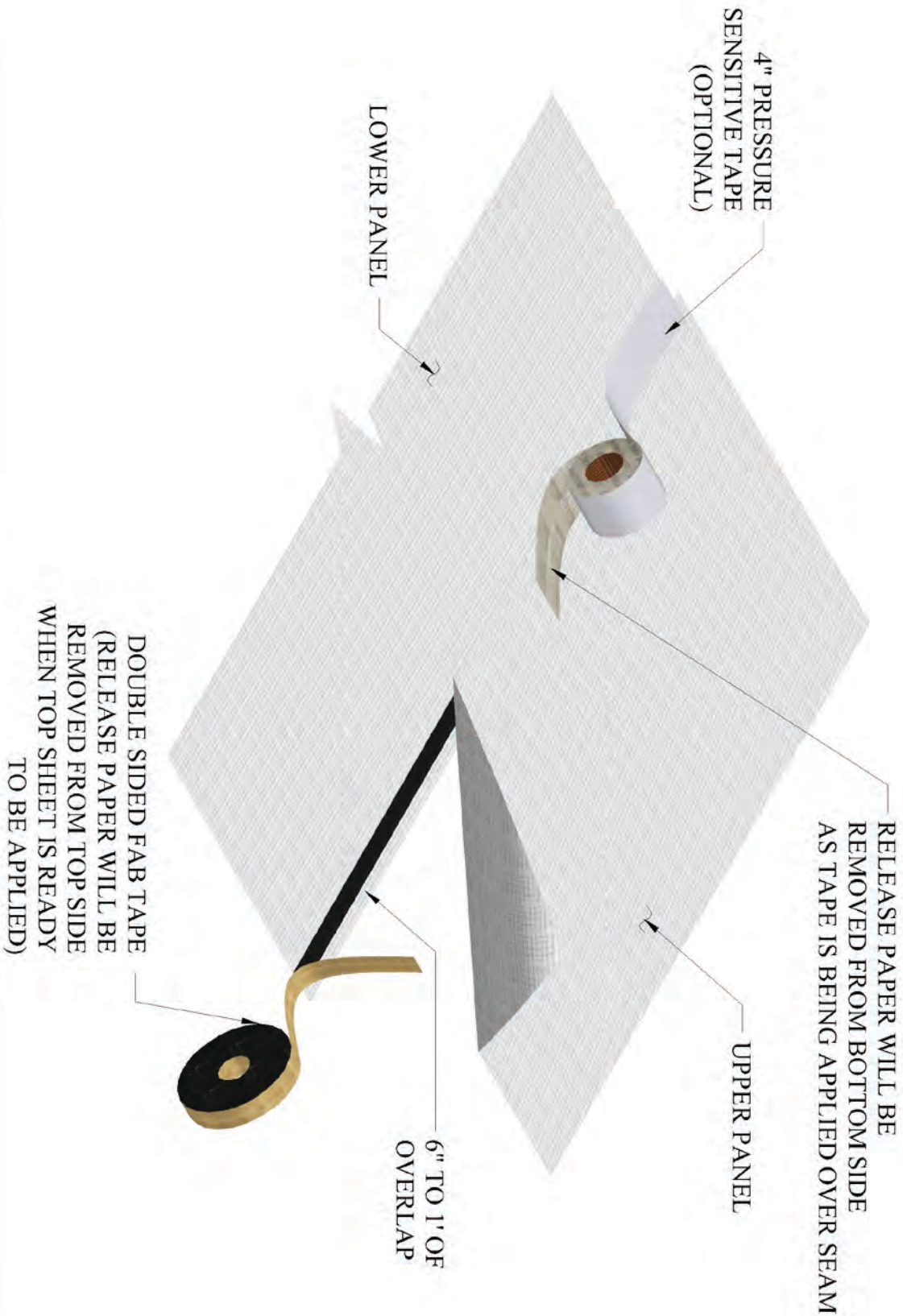

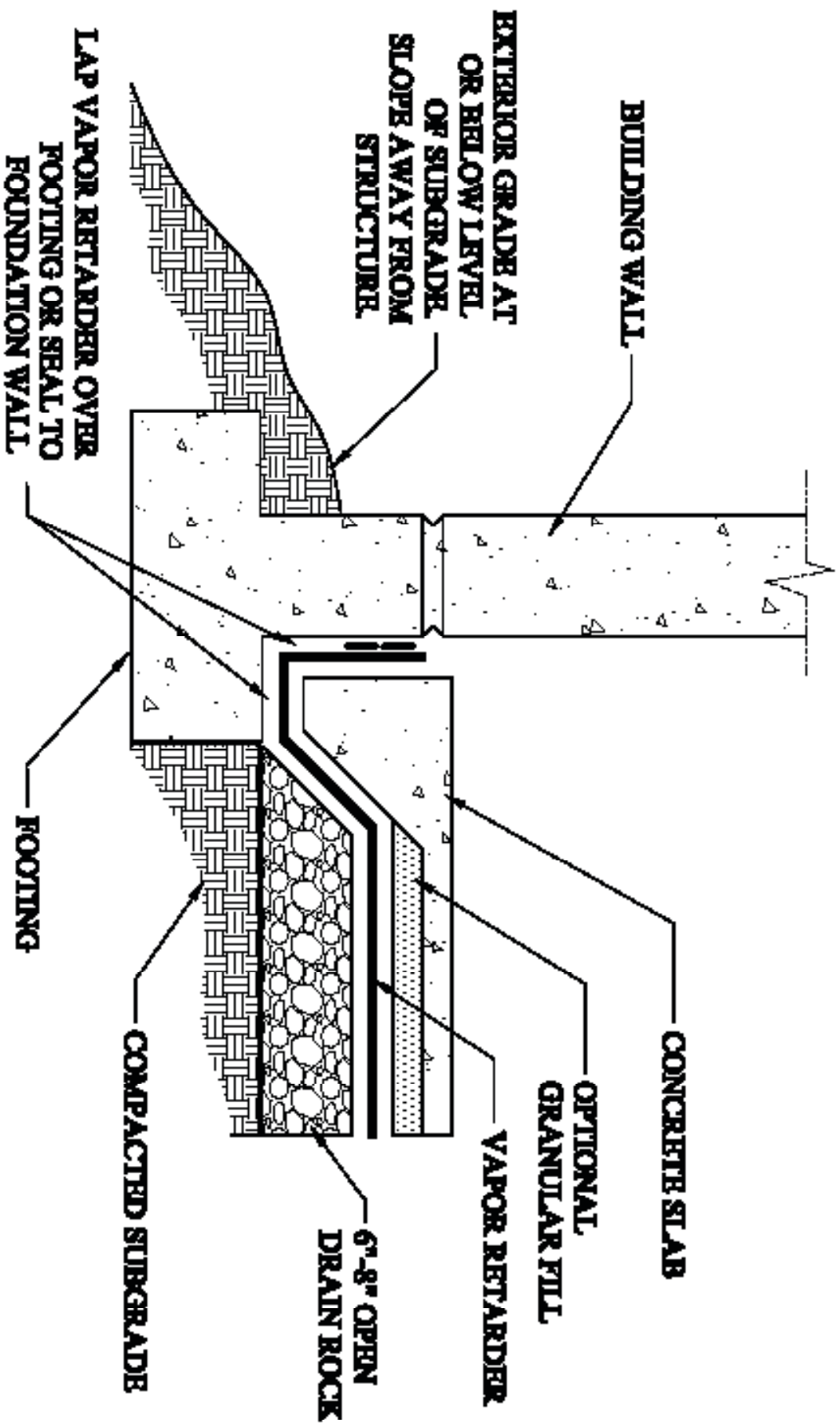
CONCRETE SLAB ON GRADE: FIG 1**GRADDBRAM DETAIL RC 4-24.3mg****FIG. 1****OPTIMUM RELATIONSHIP OF VAPOR RETARDER COMPONENTS**

2001 RESF INDUSTRIES INC. All rights reserved. No part of this document may be reproduced or copied in any form or by any means without written permission from Resf Industries Inc.

CONCRETE SLAB ON GRADE: FIG 2
GRADEBEAM DETAIL RC 4-24.dwg

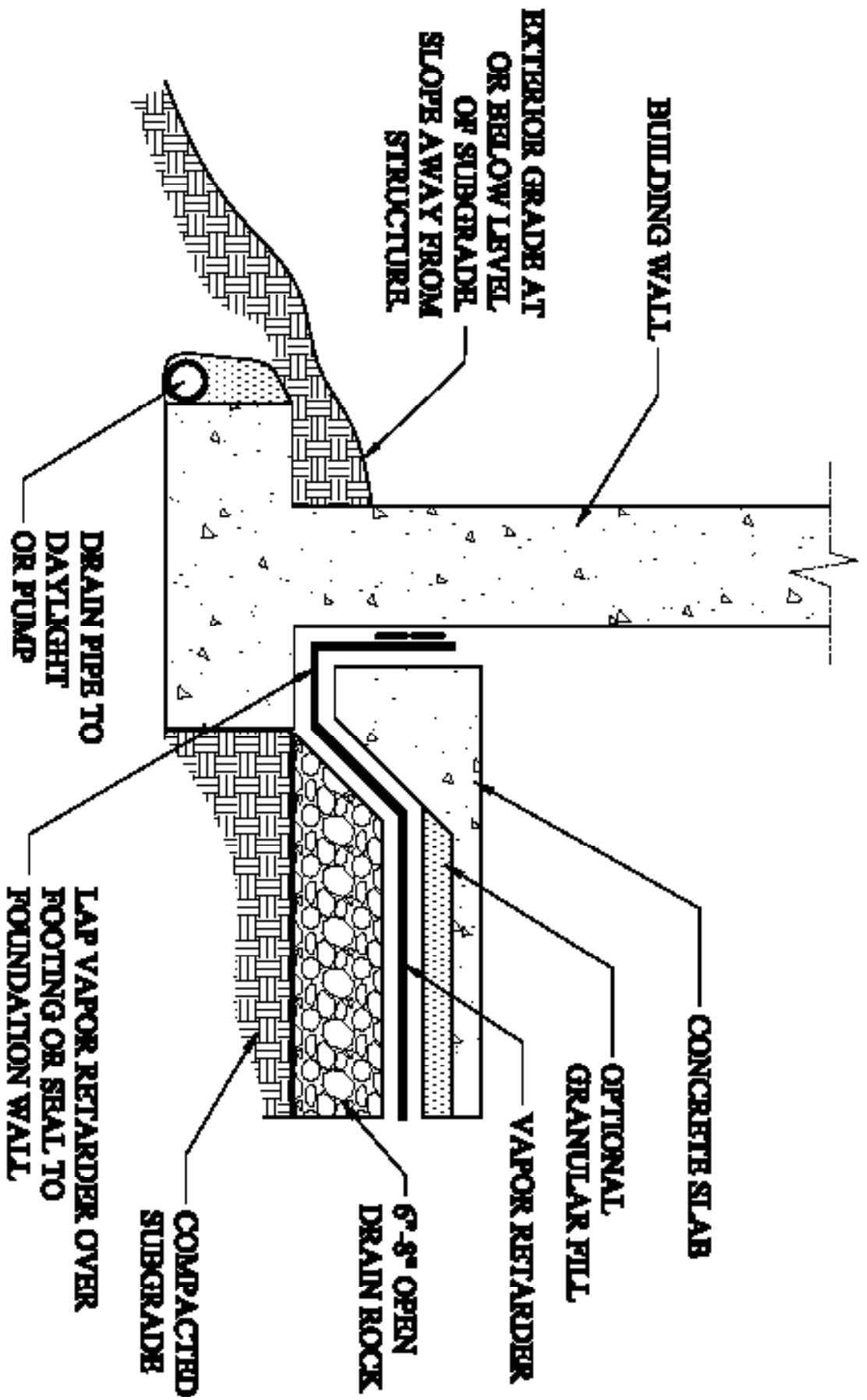
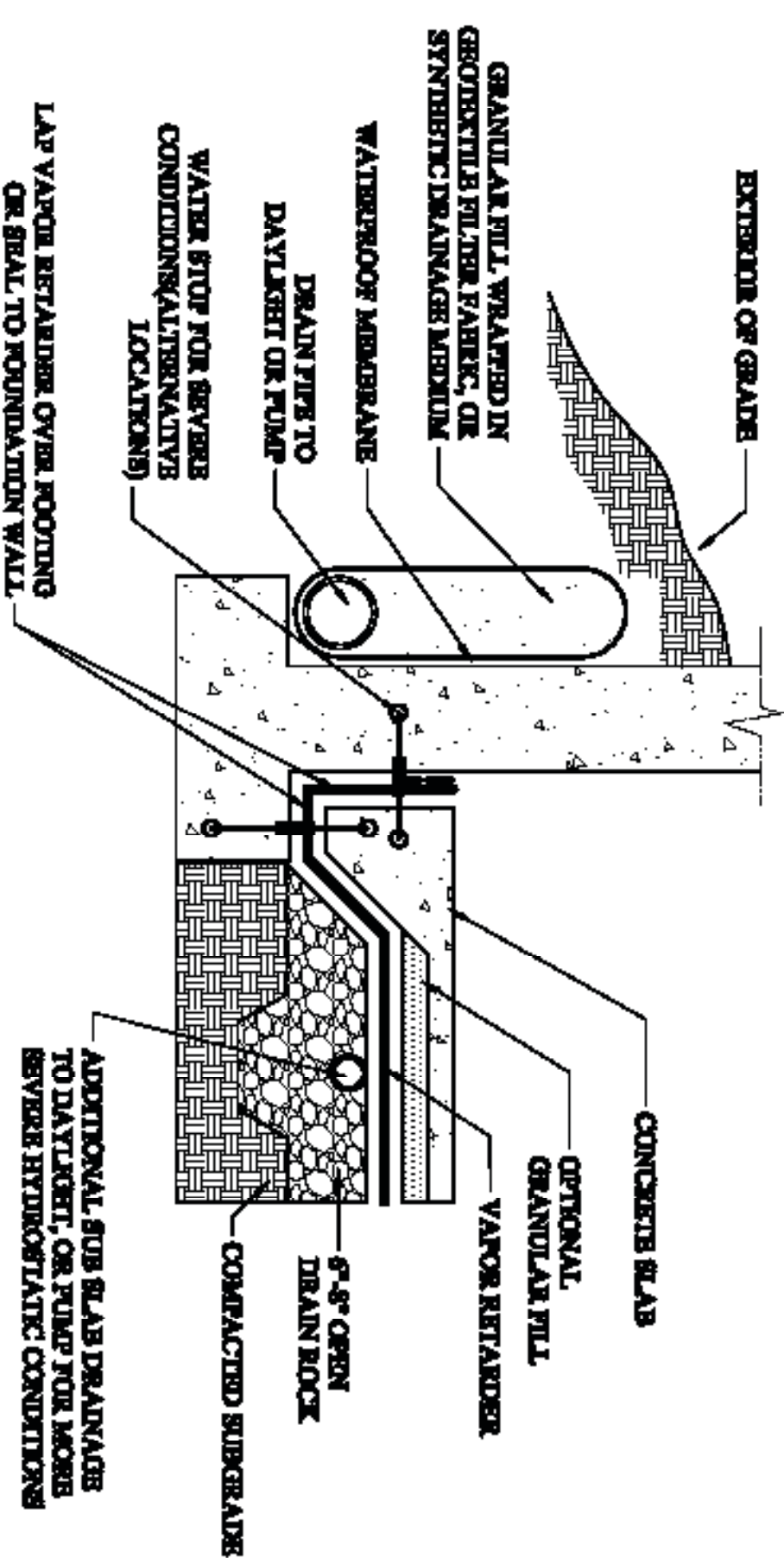

FIG. 2
CONCRETE SLAB ON GRADE: SOLUTION FOR SUBGRADE SLIGHTLY BELOW EXTERIOR GRADE

2001 REEF INDUSTRIES INC. All rights reserved. No part of this document may be reproduced or copied in any form or by any means without written permission from Reef Industries Inc.

CONCRETE SLAB ON GRADE: FIG 3

GRABBER/DITALE, EC-4-24-AM-1

**FIG. 3**

SOLUTION FOR SUBGRADE UP TO ONE STORY BELOW GRADE WITH NO HYDROSTATIC PRESSURE ON VAPOR RETARDER

2001 RESF INDUSTRIES INC. All rights reserved. No part of this document may be reproduced or copied in any form or by any means without written permission from Resf Industries Inc.



RFI
REF INDUSTRIES, INC.

CONCRETE SLAB ON GRADE: FIG 4

GRADEBEAM DETAIL RC 4-24.3mg

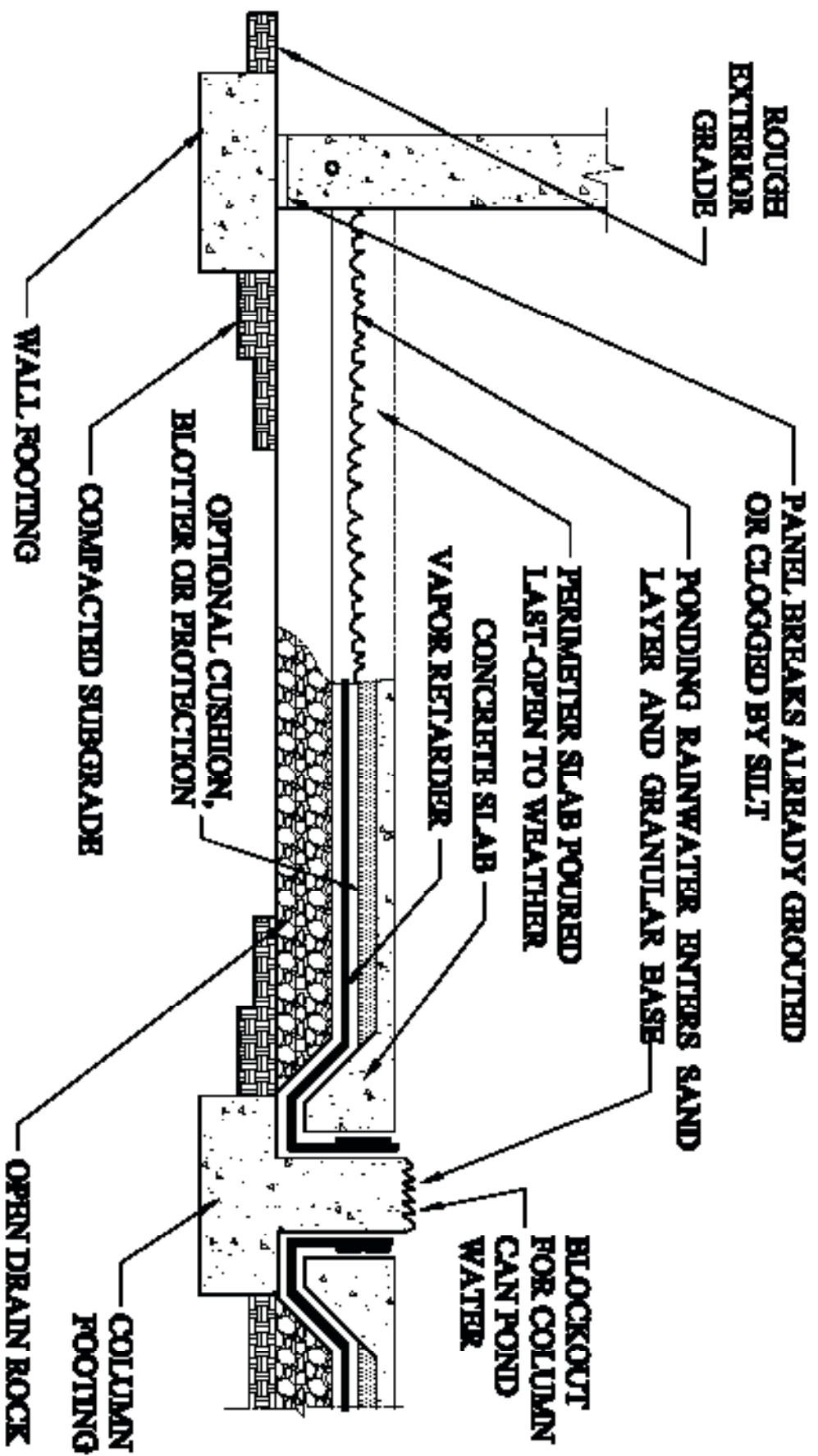

FIG. 4

HOW MOISTURE CAN BE RETAINED IN BASE OR CUSHION, BLOTTER, OR PROTECTION COURSE DURING CONSTRUCTION

2001 RHEF INDUSTRIES INC. All rights reserved. No part of this document may be reproduced or copied in any form or by any means without written permission from Reef Industries Inc.

GRIFFOLYN REPAIR

STEP 1
CLEAN A 1 - 2 FOOT AREA
AROUND ALL SIDES OF
DAMAGED AREA OF MATERIAL

STEP 2
APPLY A CONTINUOUS STRIP OF DOUBLE SIDED
BLACK FAB TAPE/CLEAR BONDING TAPE AROUND
DAMAGED AREA
(REMOVE RELEASE PAPER WHEN PATCH MATERIAL
IS READY TO BE APPLIED)

4" PRESSURE SENSITIVE TAPE
(OPTIONAL)

TEAR OR CUT

STEP 3
CUT PATCH MATERIAL
2 - 3 INCHES LARGER THAN
OUTER EDGE OF FAB TAPE

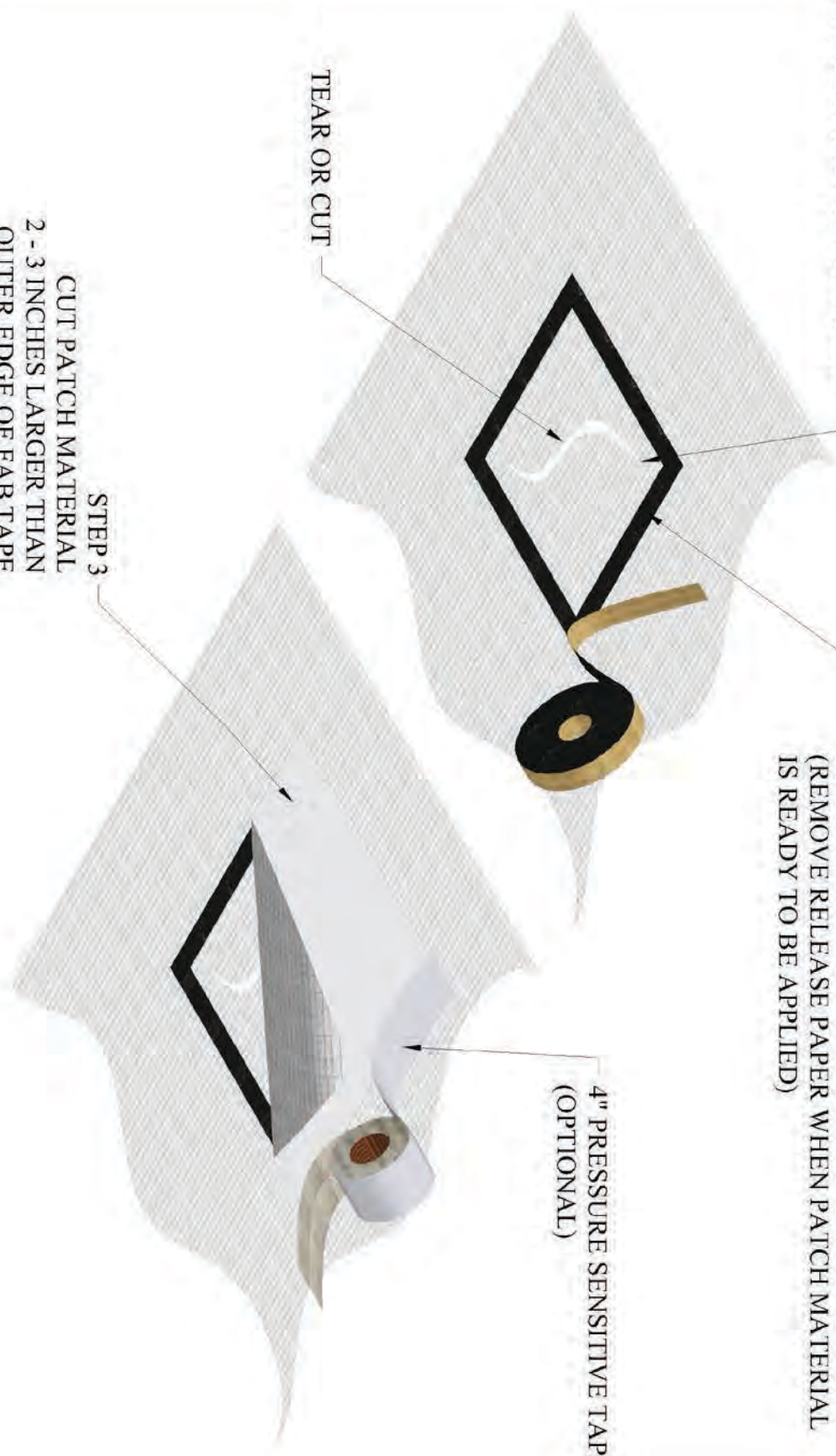

GRIFFOLYN FIRE RETARDANT Products REPAIR

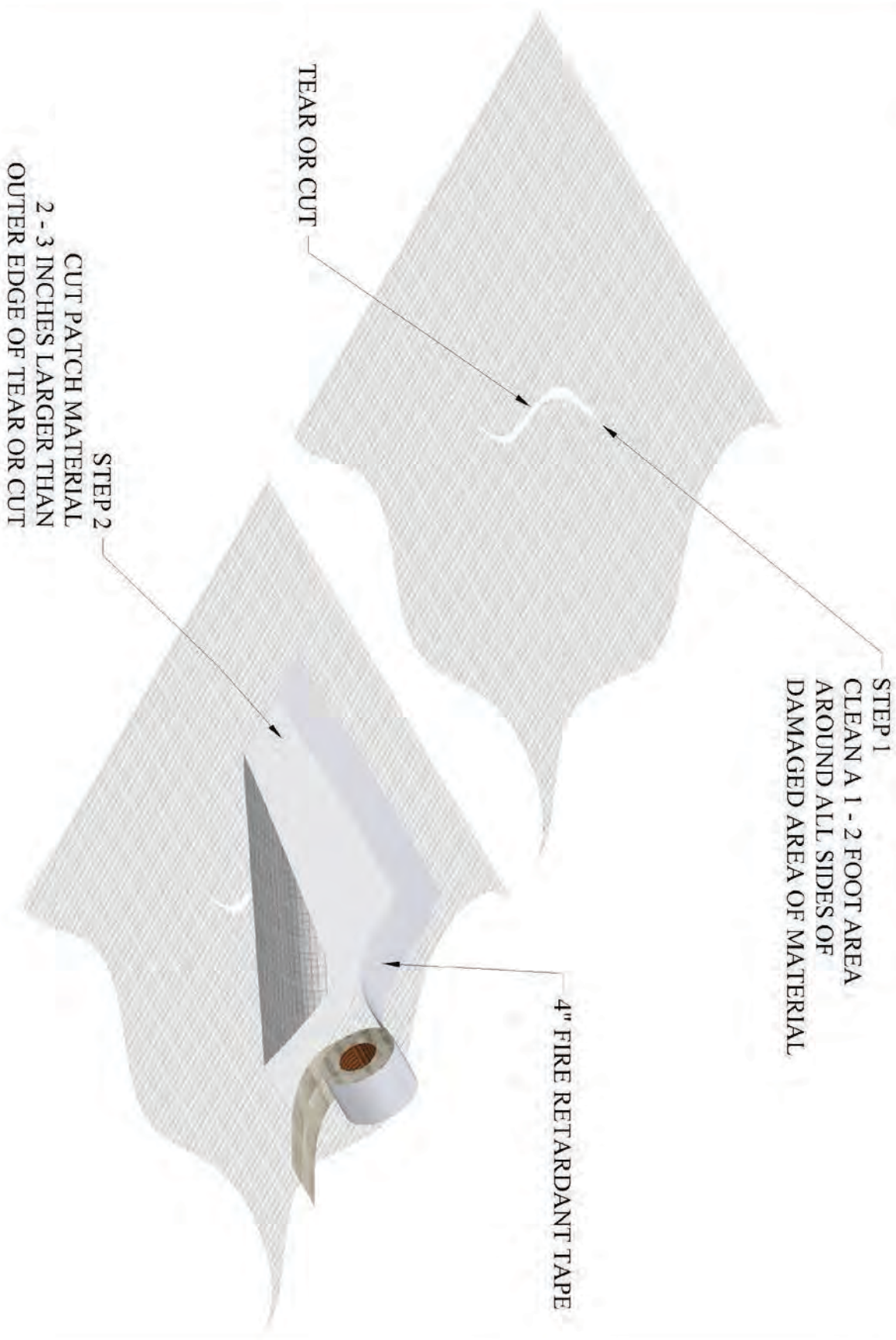

VAPOR RETARDER ATTACHMENT TO STEM WALL

STEP 3
REMOVE RELEASE LINER ON THE
FAB TAPE AND SECURE THE
VAPOR RETARDER TO THE TAPE

STEP 1
ALL DIRT AND LOOSE FINES SHOULD
BE REMOVED FROM THE INSIDE
FACE OF THE STEM WALL

STEP 2
APPLY (2) ROWS OF FAB TAPE
ON THE STEM WALL JUST BELOW
THE FINISHED FLOOR SURFACE

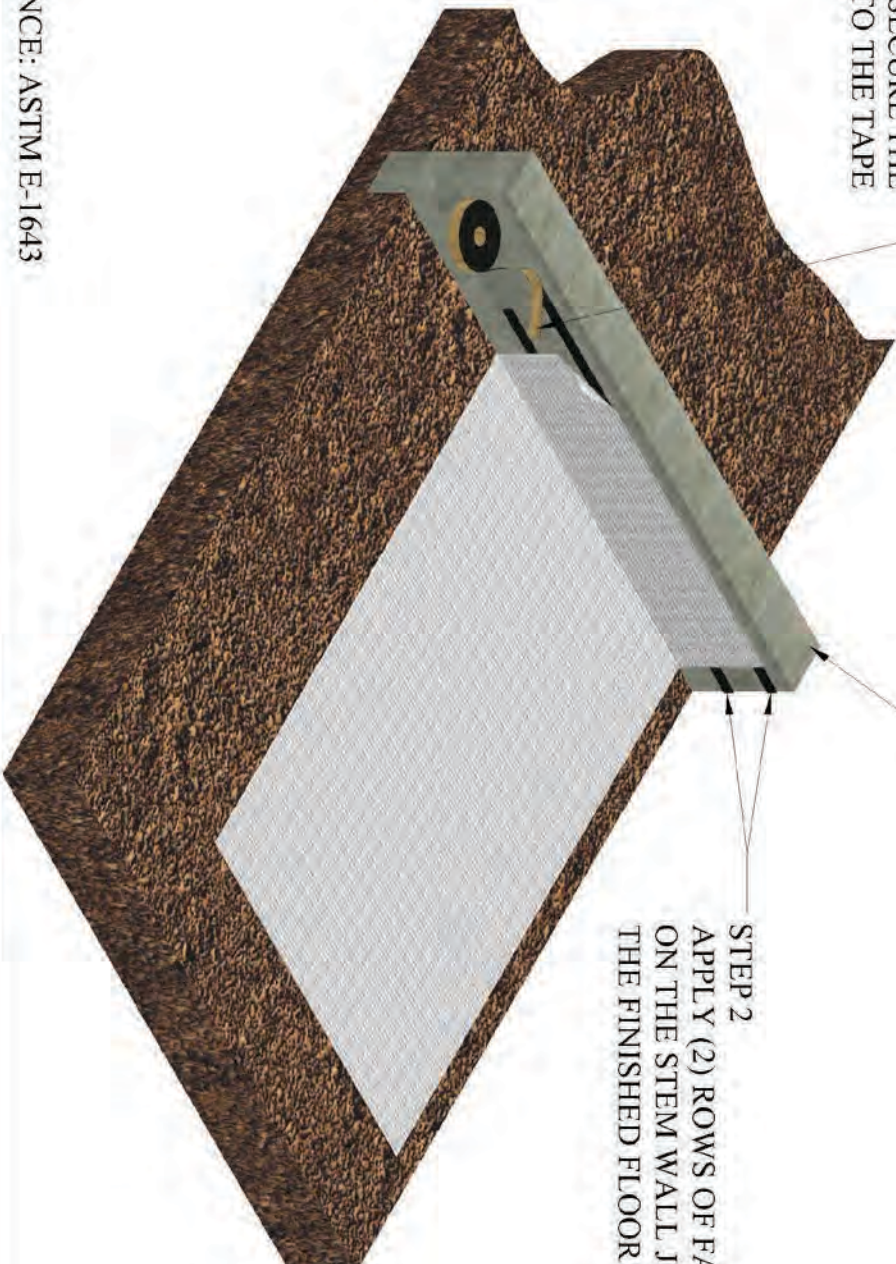

ALTERNATE REFERENCE: ASTM E-1643

DETAIL VAPOR RETARDER

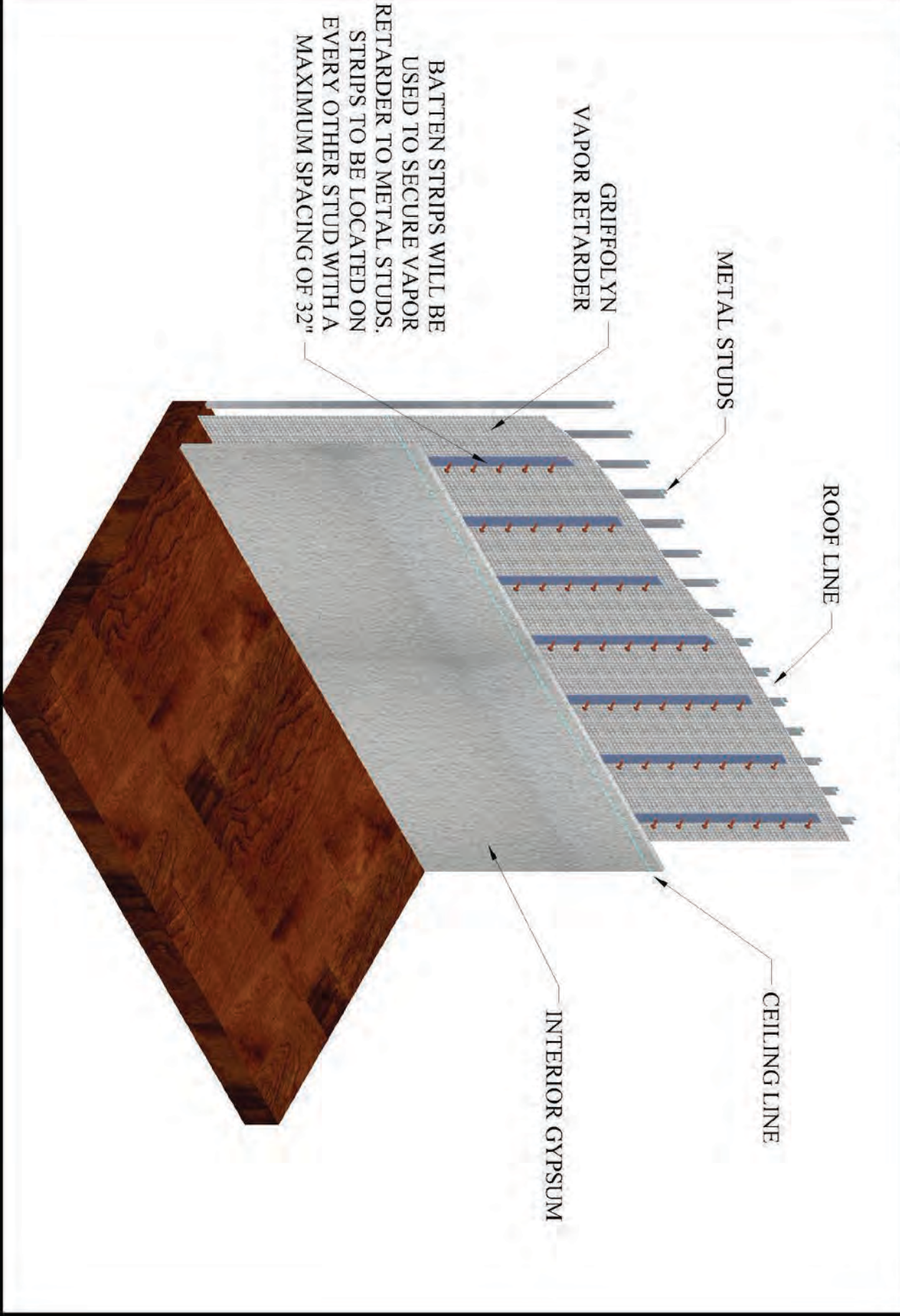

BATTEN STRIPS WILL BE USED TO SECURE VAPOR RETARDER TO METAL STUDS. STRIPS TO BE LOCATED ON EVERY OTHER STUD WITH A MAXIMUM SPACING OF 32"

DETAIL VAPOR RETARDER



VAPOR RETARDER DOOR DETAIL

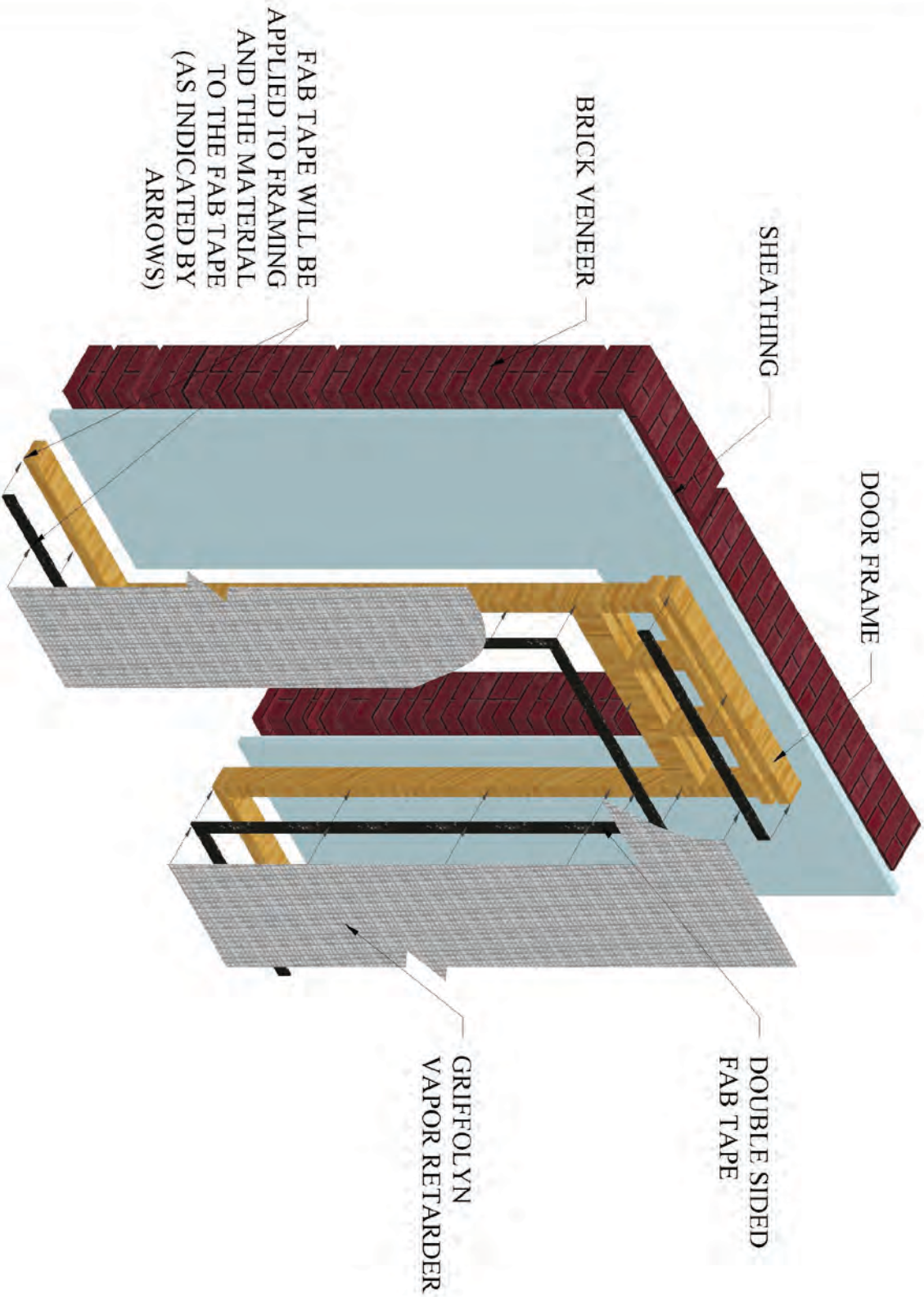

NOTE: This document provides information related to the installation of "Fab Tape", Vapor Retarder and related components. The information provided is recommended options for securing Griffolyn Vapor Retarder on an interior wall. The orientation or location of Griffolyn Vapor Retarders in a wall construction is as specified by the architect or specifier.

VAPOR RETARDER WINDOW DETAIL

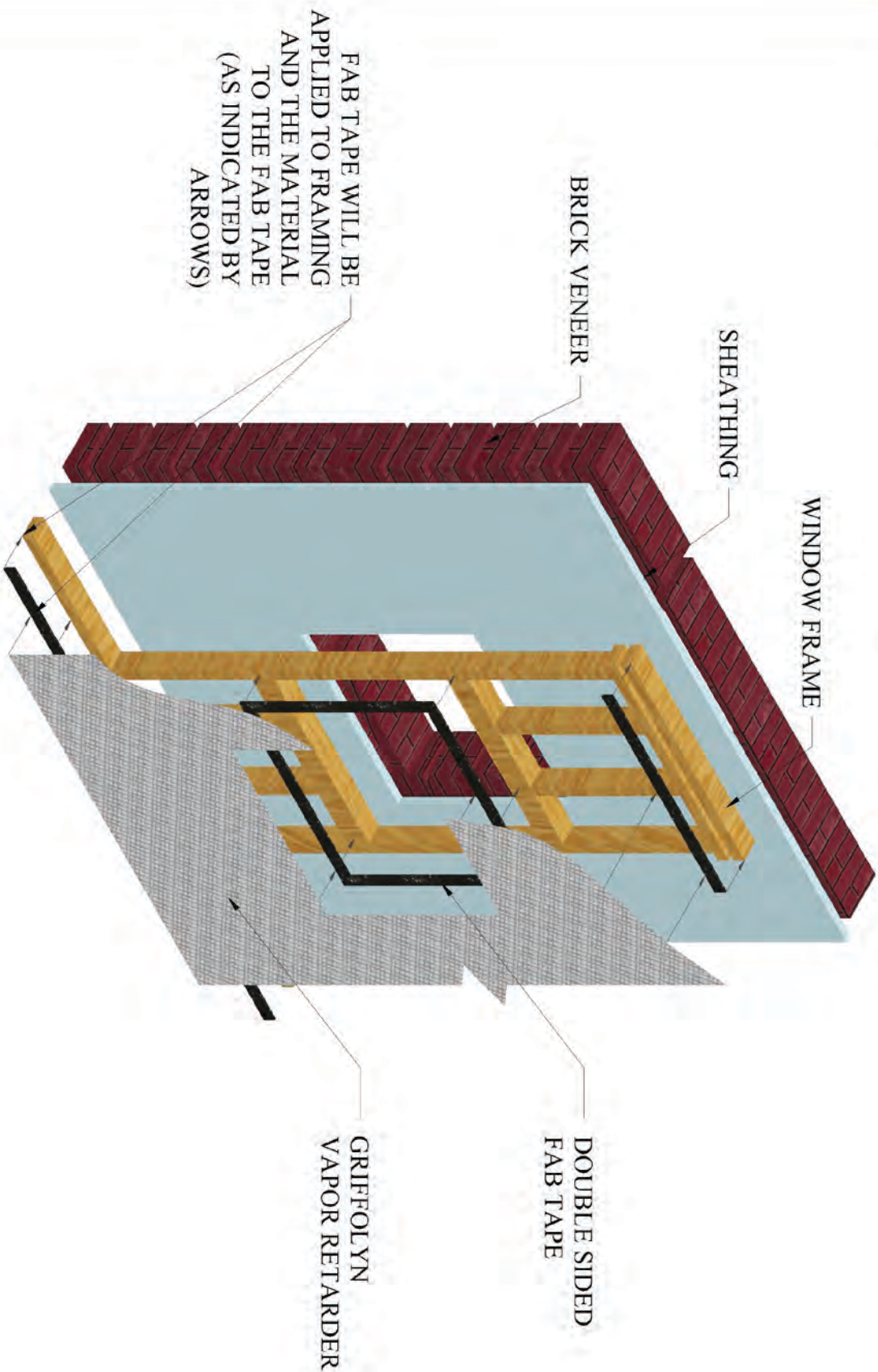

NOTE: This document provides information related to the installation of "Fab Tape", Vapor Retarder and related components. The information provided is recommended options for securing Griffolyn Vapor Retarder on an interior wall. The orientation or location of Griffolyn Vapor Retarders in a wall construction is as specified by the architect or specifier.

Griffolyn® Griff Tape™ / FR

General Installation Instructions

The surfaces to be taped should be clean and dry. The tape will not adhere if the surfaces are not properly prepared. Dirty or wet surfaces should be completely cleaned with water, paper towels, dry rags or other materials that will prepare the surface for the tape. Accumulations of dust should also be removed to insure a secure seam.

To make a taped seam, the two panels should be overlapped a minimum of 4 inches. The edges to be joined should be smooth and foldovers or wrinkles should be removed. The exposed edge of the top panel should end up in the center of the tape as it is applied. Apply the tape so that half of the tape is on the top panel and half on the bottom panel. Firm hand pressure is sufficient to bond the tape to the material.

The product obtains optimum adhesion when the surfaces to be bonded are warm. The surfaces should be above 40° F to insure an acceptable bond. In order to obtain a bond at lower temperatures, external heat may be required. The use of an industrial style hot air blower is one recommended method. Extra care should be taken when attempting to install tape at temperatures below 32° F.

REEF
INDUSTRIES, INC.



GRIFFOLYN®



Call today for technical
assistance or to place
your order.

9209 Almeda Genoa Rd.
Houston, Texas 77075

P: 713.507.4251
F: 713.507.4295

TOLL FREE
1.800.231.6074

E-mail:
ri@reefindustries.com

www.reefindustries.com
www.griffolyn.com

PIPE CLUSTER GRIFFOLYN REPAIR

STEP 1
VAPOR RETARDER WILL BE CUT
AROUND CLUSTER TO ALLOW PIPES
TO PASS THROUGH LINER

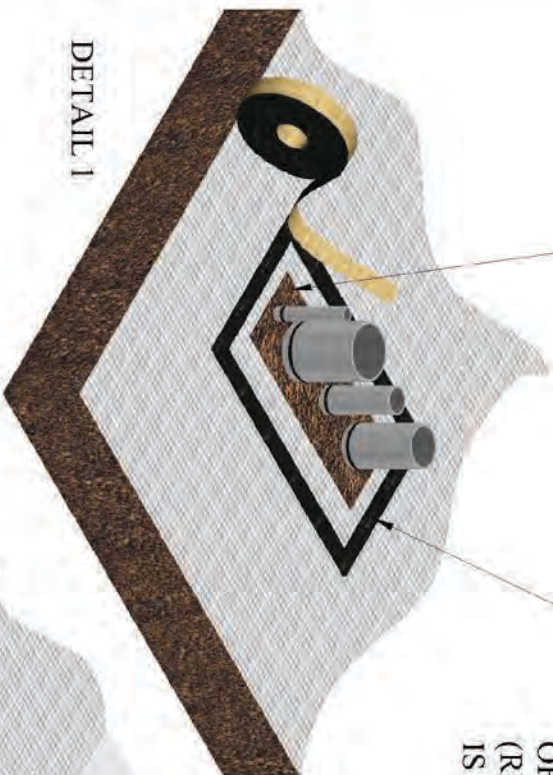

DETAIL 1

STEP 2
DOUBLE SIDED BONDING/FAB TAPE WILL
BE APPLIED AROUND ENTIRE PERIMETER
OF PIPE CLUSTER
(REMOVE RELEASE PAPER WHEN MATERIAL
IS READY TO BE APPLIED)

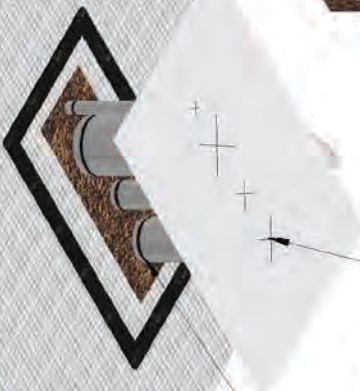

"X" REPRESENTS A SLIT
ON THE PATCH MATERIAL
("X" WILL BE SMALLER
THAN DIAMETER OF PIPE)

STEP 3
APPLY DOUBLE SIDED BONDING/
FAB TAPE AROUND BASE OF PIPE



DETAIL 2

PIPE CLUSTER GRIFFOLYN REPAIR

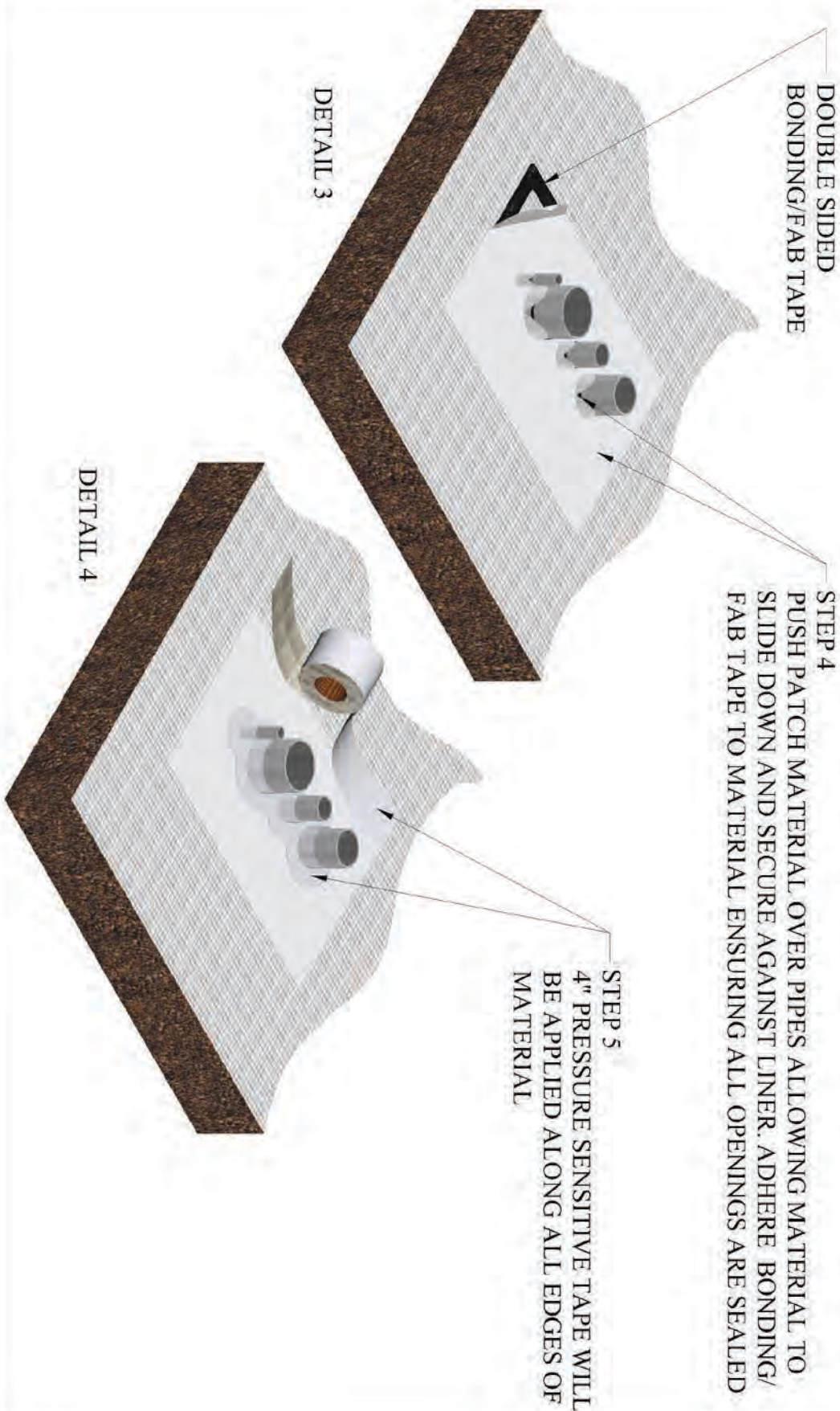

BATTEN DETAIL W/ FASTENERS

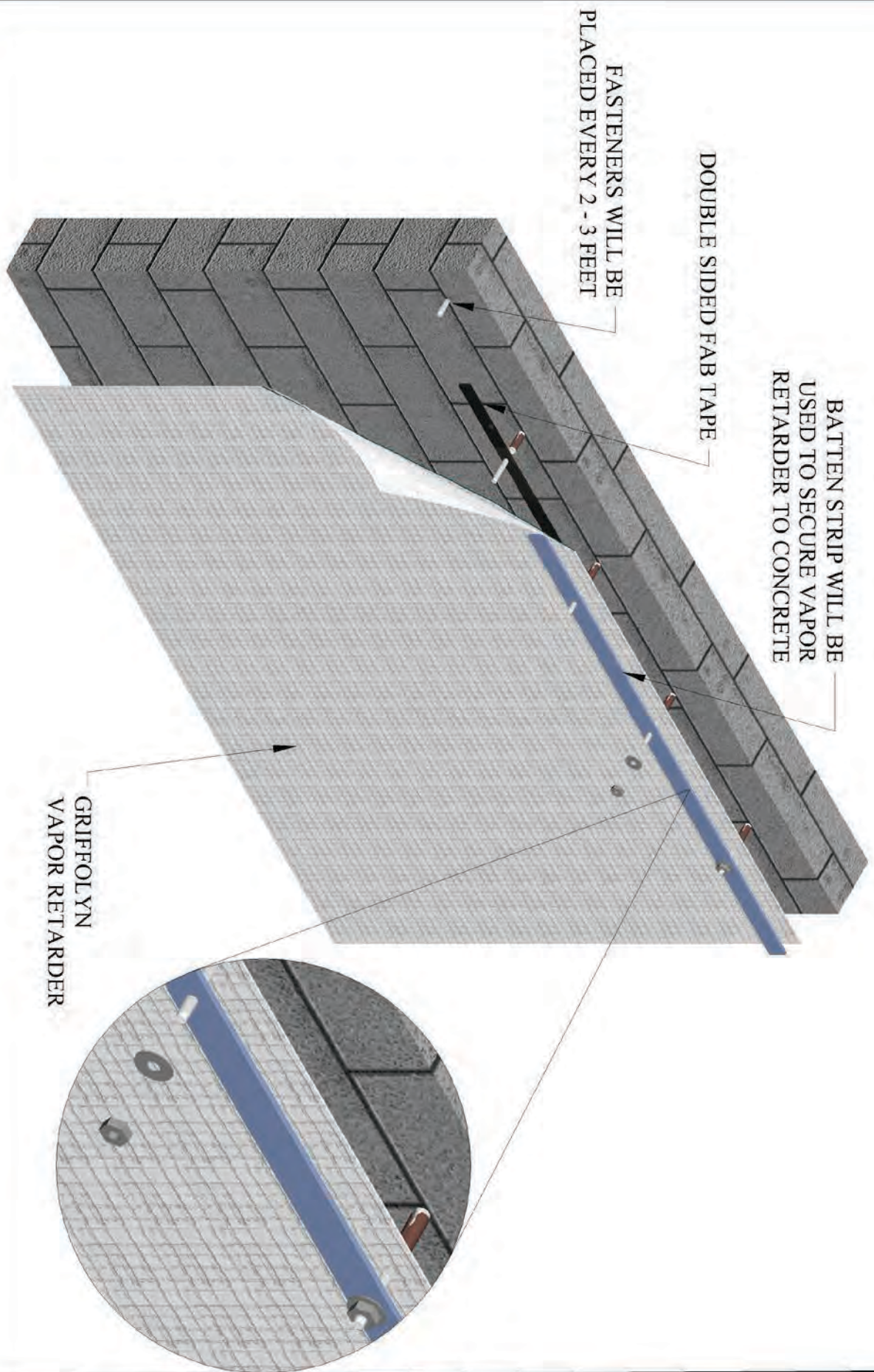

BATTEN DETAIL W/ FASTENERS

BATTEN STRIP WILL BE
USED TO SECURE VAPOR
RETARDER TO METAL STUDS

DOUBLE SIDED FAB TAPE

FASTENERS WILL BE
PLACED EVERY 2 - 3 FEET

GRIFFOLYN
VAPOR RETARDER

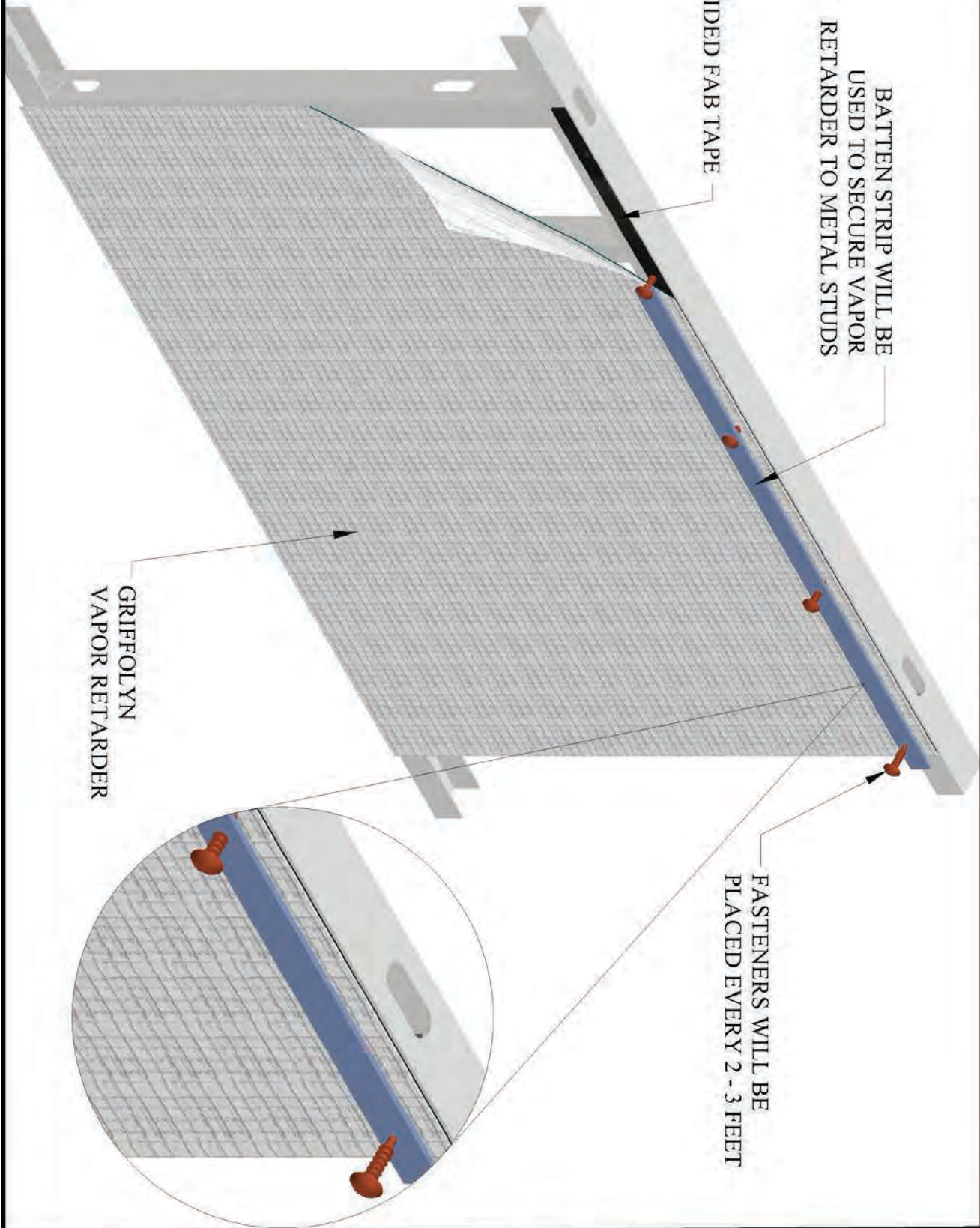

Sustainable Sites 26

| Y | ? | N | | | |
|---|---|---|------------|--|---------|
| Y | | | Prereq 1 | Construction Activity Pollution Prevention | |
| | | | Credit 1 | Site Selection | 1 |
| | | | Credit 2 | Development Density and Community Connectivity | 5 |
| | | | Credit 3 | Brownfield Redevelopment | 1 |
| | | | Credit 4 | Alternative Transportation | 1 to 10 |
| | | | Credit 5.1 | Site Development—Protect or Restore Habitat | 1 |
| | | | Credit 5.2 | Site Development—Maximize Open Space | 1 |
| | | | Credit 6.1 | Stormwater Design—Quantity Control | 1 |
| | | | Credit 6.2 | Stormwater Design—Quality Control | 1 |
| | | | Credit 7.1 | Heat Island Effect—Nonroof | 1 to 2 |
| | | | Credit 7.2 | Heat Island Effect—Roof | 1 to 2 |
| | | | Credit 8 | Light Pollution Reduction | 2 |

Water Efficiency 10

| Y | ? | N | | | |
|---|---|---|----------|------------------------------------|--------|
| Y | | | Prereq 1 | Water Use Reduction—20% Reduction | |
| | | | Credit 1 | Water Efficient Landscaping | 2 to 4 |
| | | | Credit 2 | Innovative Wastewater Technologies | 2 |
| | | | Credit 3 | Water Use Reduction | 2 to 4 |

Energy and Atmosphere 35

| Y | ? | N | | | |
|---|---|---|----------|--|---------|
| Y | | | Prereq 1 | Fundamental Commissioning of Building Energy Systems | |
| Y | | | Prereq 2 | Minimum Energy Performance | |
| Y | | | Prereq 3 | Fundamental Refrigerant Management | |
| | | | Credit 1 | Optimize Energy Performance | 1 to 19 |
| | | | Credit 2 | On-Site Renewable Energy | 1 to 7 |
| | | | Credit 3 | Enhanced Commissioning | 2 |
| | | | Credit 4 | Enhanced Refrigerant Management | 2 |
| | | | Credit 5 | Measurement and Verification | 3 |
| | | | Credit 6 | Green Power | 2 |

Materials and Resources 14

| Y | ? | N | | | |
|---|---|---|------------|--|--------|
| Y | | | Prereq 1 | Storage and Collection of Recyclables | |
| | | | Credit 1.1 | Building Reuse—Maintain Existing Walls, Floors, and Roof | 1 to 3 |
| | | | Credit 1.2 | Building Reuse—Maintain Interior Nonstructural Elements | 1 |
| | | | Credit 2 | Construction Waste Management | 1 to 2 |
| | | | Credit 3 | Materials Reuse | 1 to 2 |
| | | | Credit 4 | Recycled Content | 1 to 2 |
| | | | Credit 5 | Regional Materials | 1 to 2 |
| | | | Credit 6 | Rapidly Renewable Materials | 1 |



Credit 7 Certified Wood

1



Indoor Environmental Quality

15

Y ? N



Prereq 1 Minimum Indoor Air Quality Performance



Prereq 2 Environmental Tobacco Smoke (ETS) Control



Credit 1 Outdoor Air Delivery Monitoring

1



Credit 2 Increased Ventilation

1



Credit 3.1 Construction IAQ Management Plan—During Construction

1



Credit 3.2 Construction IAQ Management Plan—Before Occupancy

1



Credit 4 Low-Emitting Materials

1 to 5



Credit 5 Indoor Chemical and Pollutant Source Control

1



Credit 6 Controllability of Systems—Lighting and Thermal Comfort

1



Credit 7.1 Thermal Comfort—Design

1



Credit 7.2 Thermal Comfort— Employee Verification

1



Credit 8.1 Daylight and Views—Daylight

1



Credit 8.2 Daylight and Views—Views

1



Innovation and Design Process

6

Y ? N



Credit 1.1 Innovation in Design: Specific Title

1

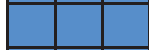

Credit 1.2 Innovation in Design: Specific Title

1



Credit 1.3 Innovation in Design: Specific Title

1



Credit 1.4 Innovation in Design: Specific Title

1



Credit 1.5 Innovation in Design: Specific Title

1



Credit 2 LEED Accredited Professional

1



Regional Priority Credits

4

Y ? N



Credit 1.1 Regional Priority: Specific Credit

1



Credit 1.2 Regional Priority: Specific Credit

1



Credit 1.3 Regional Priority: Specific Credit

1



Credit 1.4 Regional Priority: Specific Credit

1



Total

110

Certified 40 to 49 points Silver 50 to 59 points Gold 60 to 79 points Platinum 80+ points





Griffolyn® LEED's Credit Opportunities LEED (Leadership in Energy & Environmental Design)

MR Credit 2.1 Construction Waste Management: Divert 50% from Disposal
1 Point

MR Credit 2.2 Construction Waste Management: Divert 75% from Disposal
1 Point in addition to MR Credit 2.1

Griffolyn® 10 mil and 15 mil films consist of high quality polyolefin/polyethylene resin and additives and therefore any materials that are not used on this project can be used on subsequent projects. Additionally, these materials are completely recyclable allowing the contractor to include the scrap in the diverted products group reducing the amount of material disposed of in a landfill. The most appropriate recycling classification code would be Code 04.

MR Credit 5.1 Regional Materials: 10% Extracted, Processed & Manufactured Regionally
1 Point

MR Credit 5.2 Regional Materials: 20% Extracted, Processed & Manufactured Regionally
1 Point in addition to MR Credit 5.1

The intent of this section is to use local materials minimizing transportation costs. The local area is anywhere within 500 miles of the project site. 100% of the components of the Griffolyn® 10 and 15 mil products are produced in Houston, Texas area.

SS Credit 3 Brownfield Development
1 Point

Construction on previously built sites occurs on a regular basis and is also occurring on sites in the past that would have been dismissed because of some sort of contamination creating an environmental concern. The extremely low permeability of the Griffolyn 10 and 15 mil films, in addition to its inert composition allows it to be considered for projects involving contaminated soils.





REEF INDUSTRIES, INC.

The Manufacturing Leader of Specialized Industrial Plastic Films Since 1957.

GRIFFOLYN® PRODUCTS FOR LEED (Leadership in Energy and Environmental Design)

Reef Industries, Inc. is committed to provide products that meet the challenges and criteria of today's construction market. Areas where our materials may provide significant advantages are to help reduce waste, to be used for alternate applications or by supplying products that are locally generated. Griffolyn® 10 mil and 15 mil films are both non-hazardous, recyclable materials that assist certification to LEED's green building program. Since these products are made from high quality virgin polyolefin/polyethylene, they are completely recyclable, allowing the contractor to include left-over scrap film in the diverted products group, reducing the amount of material disposed in a landfill. However, jobsite personnel must identify, classify, and recycle materials whenever possible. The most appropriate recycling classification code for the 10 and 15 mil materials is Code 04.

To help reduce fuel consumption and air pollution while earning LEED credit, materials must be extracted, processed, and manufactured regionally within 500 miles of the project jobsite. 100% of the components of the Griffolyn® 10 and 15 mil products are produced in the Houston, Texas area.

Construction on previously built sites occurs on a regular basis and is also occurring on sites that in the past would have been dismissed because of contamination creating an environmental concern. The extremely low permeability of Griffolyn® 10 and 15 mil, in addition to its inert composition, allows it to be considered on projects involving contaminated soils.

Reef Industries, Inc. will continue to explore additional areas where we feel our products can provide alternate options and additional credits for LEED's green building program. When those products have been evaluated, we will provide them as an alternative to the current 10 and 15 mil products. If you have any questions or need additional information please do not hesitate to contact us.

Regards,
Technical Services
Reef Industries, Inc.

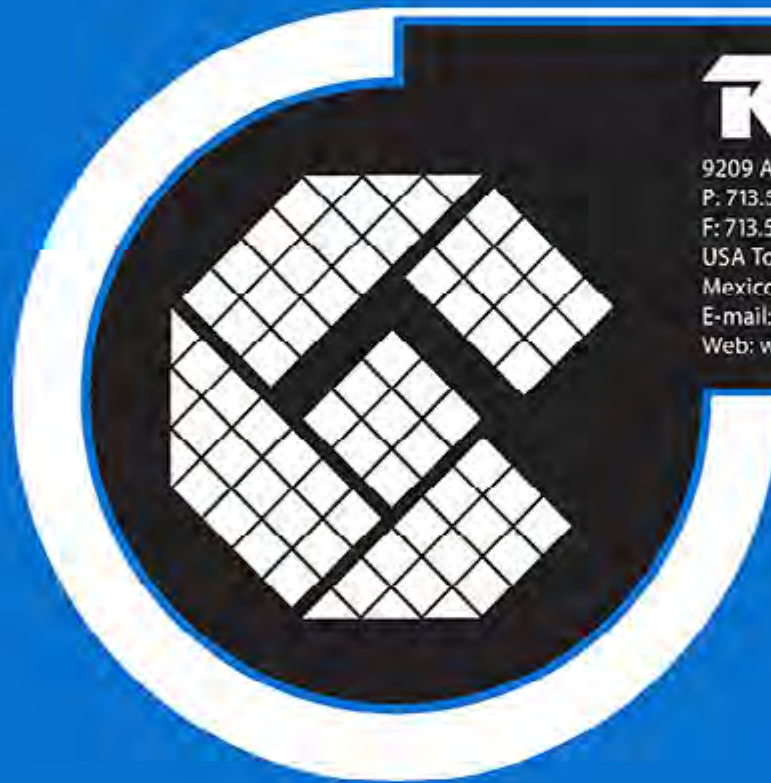

RI REEF
INDUSTRIES, INC.

9209 Almeda Genoa Rd • Houston, Texas 77075

P: 713.507.4251

F: 713.507.4295

USA Toll Free: 1.800.231.6074

Mexico: 001 800 426 1447

E-mail: ri@reefindustries.com

Web: www.reefindustries.com • www.griffolyn.com